



**K A C O**   
new energy.

**Powador**  
**12.0 TL3 - INT**  
**14.0 TL3 - INT**  
**18.0 TL3 - INT**  
**20.0 TL3 - INT**

## **Operating Manual**

- **English translation of German original**

These instructions form part of the product and must be observed. They must also be stored in a place which is freely accessible at all times.



# Operating Manual

EN

## Contents

<b>1</b>	<b>General information ..... 4</b>	7.7	Sealing the connection area ..... 27
1.1	About this document..... 4	7.8	Switching on the device ..... 28
1.2	Layout of Instructions..... 4	<b>8</b>	<b>Configuration and Operation..... 29</b>
<b>2</b>	<b>Safety ..... 5</b>	8.1	Controls..... 29
2.1	Proper use ..... 6	8.2	Initial start-up ..... 32
2.2	Protection features ..... 6	8.3	Menu structure..... 32
2.3	More information ..... 6	8.4	Monitor inverter..... 42
<b>3</b>	<b>Description ..... 7</b>	8.5	Performing a software update ..... 44
3.1	Mode of Operation ..... 7	<b>9</b>	<b>Maintenance/Troubleshooting ..... 45</b>
3.2	Diagram ..... 7	9.1	Visual inspection..... 45
<b>4</b>	<b>Technical Data ..... 10</b>	9.2	Cleaning the inverter externally ..... 45
4.1	Electrical data ..... 10	9.3	Replacing or cleaning the fan..... 45
4.2	Mechanical data..... 11	9.4	Shutting down for maintenance and troubleshooting..... 46
4.3	Identification..... 11	9.5	Disconnecting connections..... 47
<b>5</b>	<b>Transportation and Delivery ..... 12</b>	9.6	Faults..... 48
5.1	Delivery..... 12	9.7	“Fault” messages on the display/LED ..... 50
5.2	Transportation..... 12	<b>10</b>	<b>Service..... 54</b>
<b>6</b>	<b>Mounting ..... 13</b>	<b>11</b>	<b>Shutdown/Disassembly..... 55</b>
6.1	Unpacking..... 14	11.1	Shutting down the inverter ..... 55
6.2	Installing the unit ..... 15	11.2	Uninstalling the device ..... 55
<b>7</b>	<b>Electrical connection ..... 16</b>	11.3	Disassembling the unit ..... 55
7.1	Preparing the AC connection..... 16	11.4	Packaging the unit ..... 56
7.2	Connection to the power grid ..... 18	11.5	Storing the unit..... 56
7.3	Preparing the DC connection ..... 19	<b>12</b>	<b>Disposal ..... 56</b>
7.4	Connecting the PV generator ..... 20	<b>13</b>	<b>EU Declaration of Conformity ..... 57</b>
7.5	Grounding the housing ..... 23		
7.6	Connecting the interfaces..... 24		

# 1 General information

## 1.1 About this document

 **WARNING**



**Improper handling of the device can be hazardous!**

› You must read and understand the operating instructions so that you can install and use the device safely!

### 1.1.1 Other applicable documents

During installation, observe all assembly and installation instructions for components and other parts of the system. These instructions also apply to the equipment, related components and other parts of the system.

Some of the documents which are required for the registration and approval of your photovoltaic (PV) system are included with the operating instructions.

### 1.1.2 Storing the documents

These instructions and other documents must be stored near the system and be available at all times. The content of these instructions is revised on a regular basis and updated if necessary. You can download the current version of the operating instructions at [www.kaco-newenergy.com](http://www.kaco-newenergy.com).

### 1.1.3 English translation of German original

These operating instructions have been produced in several languages. The German-language version of the operating instructions is the original version. All other language versions are translations of the original operating instructions.

## 1.2 Layout of Instructions

### 1.2.1 Symbols used



General hazard



Risk of fire or explosion



High voltage



Risk of burns

 **Authorised electrician**

Only authorised electricians are permitted to carry out tasks indicated with this symbol!

### 1.2.2 Safety warnings symbols guide

 **DANGER**



**High risk**

Failure to observe this warning will lead directly to serious bodily injury or death.

 **WARNING**



**Potential risk**

Failure to observe this warning may lead to serious bodily injury or death.

 **CAUTION**



**Low-risk hazard**

Failure to observe this warning will lead to minor or moderate bodily injury.

**CAUTION**
**Risk of damage to property**

Failure to observe this warning will lead to property damage.

EN

### 1.2.3 Additional information symbols

**NOTE**

Useful information and notes

EN

**Country-specific function**

Functions restricted to one or more countries are labelled with country codes in accordance with ISO 3166-1.

### 1.2.4 Instructions symbols guide

**Instructions**

- ↻ Prerequisites before carrying out the following instructions
- ☞ Carry out step.
- ☞ (Additional steps, if applicable)
- » Result of the step(s) (optional)

### 1.2.5 Target group

All activities described in the document may only be carried out by specially trained personnel with the following qualifications:

- Knowledge about functioning and operation of an inverter
- Training in the handling of hazards and risks during the installation and operation of electrical devices and systems
- Education concerning the installation and startup of electrical devices and systems
- Knowledge of applicable standards and directives
- Knowledge and adherence to this document with all safety notices.

## 2 Safety

**DANGER**

**Lethal voltages are still present in the terminals and cables of the inverter even after the inverter has been switched off and disconnected.**

Severe injuries or death if the cables and/or terminals in the inverter are touched.

Only appropriately qualified and authorised electricians may open, install or maintain the inverter.

- › Keep the inverter closed when the unit is in operation.
- › Do not touch the cables and/or terminals when switching the unit on and off.
- › Do not make any modifications to the inverter.

The electrician is responsible for observing all existing standards and regulations.

- Keep unauthorised persons away from the inverter and PV system.
- In particular, be sure to observe the standard IEC-60364-7-712:2002 "Requirements for special installations or locations – solar photovoltaic (PV) power supply systems".
- Ensure operational safety by providing proper grounding, conductor dimensioning and appropriate protection against short circuiting.

- Observe all safety instructions on the inverter and in these operating instructions.
- Switch off all voltage sources and secure them against being inadvertently switched back on before performing visual inspections and maintenance.
- When taking measurements while the inverter is live:
  - Do not touch the electrical connections.
  - Remove all jewellery from your wrists and fingers.
  - Ensure that the testing equipment is in safe operating condition.
- Stand on an insulated surface when working on the inverter.
- Modifications to the surroundings of the inverter must comply with the applicable national and local standards.
- When working on the PV generator, it is also necessary to switch off the DC voltage with the DC isolator switch in addition to disconnecting the PV generator from the grid.

## 2.1 Proper use

The inverter converts the DC voltage generated by the PV modules into AC voltage and feeds it into the grid. The inverter is built according to the latest technological standards and safety regulations. Nevertheless, improper use may cause lethal hazards for the operator or third parties, or may result in damage to the unit and other property.

Operate the inverter only with a permanent connection to the public power grid.

Any other or additional use of the device shall be regarded as improper. This includes:

- Mobile use,
- Use in rooms where there is a risk of explosion,
- Use in rooms where the humidity is higher than 95%
- Operation outside of the specifications intended by the manufacturer
- Modifying the device
- Standalone operation.

## 2.2 Protection features

The following monitoring and protection functions are built-in:

- Overvoltage conductors/varistors to protect the power semiconductors from high-energy transients on the grid and generator side
- Temperature monitoring of the heat sink
- EMC filters to protect the inverter from high-frequency grid interference
- Grid-side grounded varistors to protect the inverter against burst and surge pulses
- Islanding detection according to the current standards.

## 2.3 More information



### NOTE

The EU Declaration of Conformity can be found in the appendix.

For information on grid coupling, grid protection and safety parameters along with more detailed instructions see our web site at <http://www.kaco-newenergy.de/>.

## 3 Description

### 3.1 Mode of Operation

The inverter converts the DC voltage generated by the PV modules into AC voltage and feeds it into the grid. The starting procedure begins when there is sufficient sunlight and a specific minimum voltage is present in the inverter. The feed-in process begins once the PV generator has passed the insulation test and the grid parameters are within the requirements imposed by the grid operator for a specific monitoring time. If, as it gets dark, the voltage drops below the minimum voltage value, feed-in operation ends and the inverter switches off.

### 3.2 Diagram

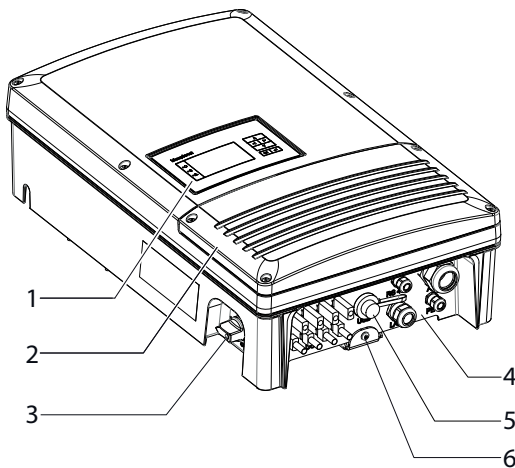

Figure 1: Inverter diagram

#### Key

1	Housing with control panel	4	Connection board
2	Cover for the connection area	5	USB interface
3	DC isolator switch	6	Mounting plate

#### 3.2.1 Mechanical components

##### DC isolator switch

The DC isolator switch is located on the bottom side of the inverter housing. The DC isolator switch is used to disconnect the inverter from the PV generator in order to carry out service.

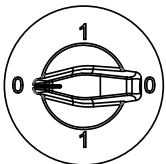

Figure 2: DC isolator switch

##### Disconnecting the inverter from the PV generator

- ☞ Switch the DC isolator switches from 1 (ON) to 0 (OFF).

##### Connecting the inverter to the PV generator

- ☞ Switch the DC isolator switches from 0 (OFF) to 1 (ON).

#### 3.2.2 Electrical functions

A potential-free relay contact is integrated in the inverter. Use this contact for one of the following functions:

## Fault signal relay

The potential-free relay contact closes as soon as there is a fault during operation. You use this function, for example, to signal a fault visually or acoustically.

## Priwatt

The energy that is provided by the PV system can be put to use directly by the appliances that are connected in your home.

The potential-free contact can switch larger appliances (e.g. air conditioning units) on and off with the “priwatt” function activated. This requires an external power supply and an external load relay.

When the function is active, either the remaining runtime (in hours and minutes) or the shutdown threshold (in kW) is displayed on the start screen depending on the operating mode selected. The “priwatt” function is not active in the unit’s delivery state. The option can be configured in the Settings menu.

## 3.2.3 Interfaces

You configure the interfaces and the web server in the Settings menu.

The inverter has the following interfaces for communication and remote monitoring:

### Ethernet interface

Monitoring can occur directly on the unit using the integrated Ethernet interface. A local web server is installed in the unit for this purpose.

For monitoring a system comprising several inverters, we recommend you use an external data logging and monitoring system.

### RS485 interface

In addition to the monitoring via the Ethernet interface, the monitoring can be executed via the RS485 interface. For monitoring your PV system using the RS485 interface, KACO new energy GmbH offers monitoring devices:

### USB interface

The USB connection of the inverter is a type A socket. It is located on the connection board on the underside of the inverter under a cover. The USB connection is specified to draw 100 mA of power. Use the USB interface to read out stored operating data and to load software updates using a FAT32-formatted USB stick.

### S0 interface (optional)

The S0 interface transmits pulses between a pulsing counter and a tariff metering unit. It is a galvanically isolated transistor output. It is designed according to DIN EN 62053-31:1999-04 (pulse output devices for electromechanical and electronic meters).

The S0 interface pulse rate can be chosen in three unit intervals (500, 1,000 and 2,000 pulses/kWh).

protect manual and the instructions for use of the Powador protect on the KACO web site.

### “Inverter Off” input

If Powador protect is installed as a central grid and system protection, the fail-safe disconnection of suitable KACO inverters from the public grid can be initiated by a digital signal instead of tie circuit-breakers. This requires the inverters in the photovoltaic system to be connected to the Powador protect.

If a Powador-protect is used for fast shutdown, it must be used as grid protection. The RS485 interface is not required for this.

Information on installation and use can be found in this manual, in the Powador protect manual and in the instructions for use of the Powador protect on the KACO web site.



### 3.2.4 Inverter as part of a PV system

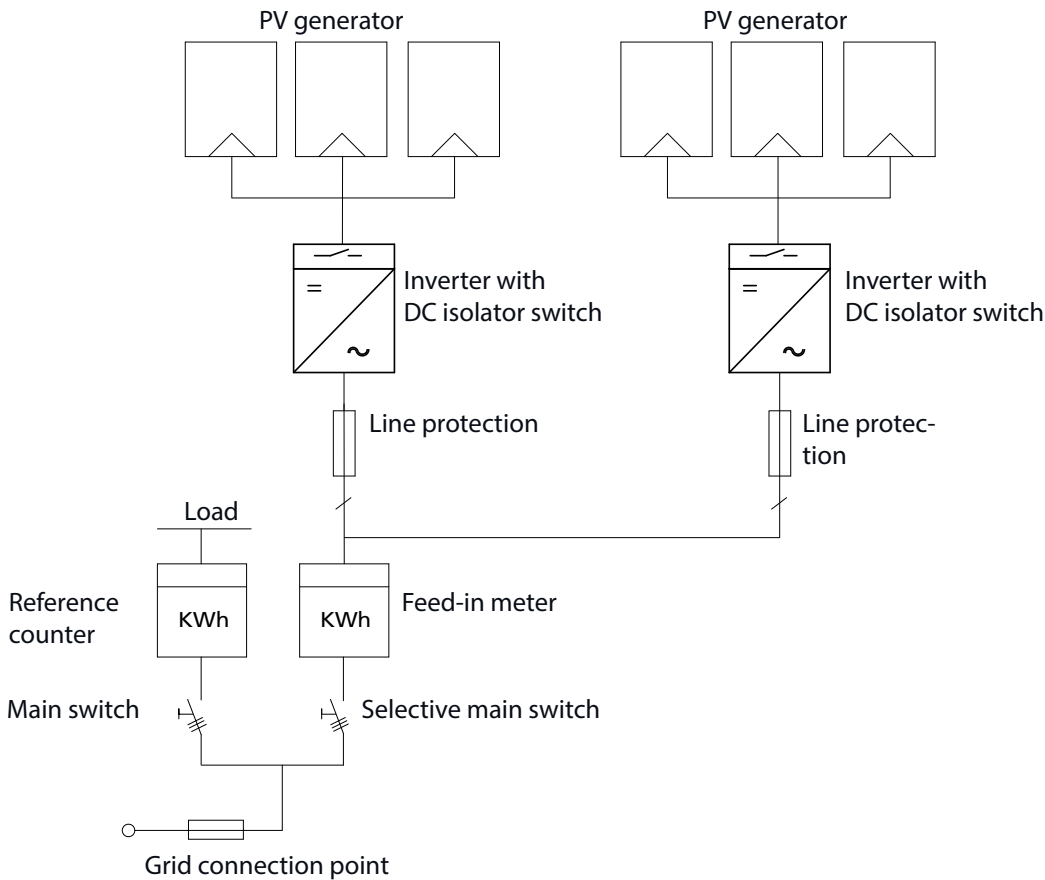

Figure 3: Circuit diagram of a system with two inverters

Key	Definition / Information about the connection
PV generator	The PV generator, i.e. the PV modules, converts the radiant energy of sunlight into electrical energy.
Inverter with:	
- DC connection	The PV generator is connected directly to the inverter's DC connection. Two strings can be connected to the DC connection.
- DC isolator switch	Use the DC isolator switch to disconnect the inverter from all power sources on the PV generator side.
Circuit breaker	A circuit breaker is an overcurrent protection device.
Feed-in meter	The feed-in meter is to be specified and installed by the power supply company. Some power supply companies also allow the installation of your own calibrated meters.
Selective main switch	If you have questions about the selective main switch, contact your power supply company.

## 4 Technical Data

### 4.1 Electrical data

Input levels	12.0 TL3	14.0 TL3	18.0 TL3	20.0 TL3
Recommended power range of the generator [kW]	12	14	18	20
DC MPP range from [V] to [V]	280 ... 800	350 ... 800	420 ... 800	470 ... 800
Operating range from [V] to [V]	200 ... 950			
Starting voltage [V]*	250			
No-load voltage ( $U_{OCmax}$ ) [V]	1,000 (start up to 1,000)			
Max. input current [A]	2 x 18.6			
Max. power per MPP tracker [W]	10,200	12,800	14,900	14,900
Number of strings	2 x 2			
Number of MPP trackers	2			
max. short-circuit current ( $I_{SCmax}$ ) [A]	2 x 22.4			
max. input source feedback current [A]	0			
Polarity safeguard	Short-circuit diode			
Output levels				
Rated power [VA]	10,000	12,500	15,000	17,000
Grid voltage [V]	400/230 (3/N/PE)			
Rated current [A]	3 x 14.5	3 x 18.1	3 x 21.8	3 x 24.6
Contribution to maximum peak current $I_p$ (ip)	62,4			
Short circuit current ( $I_k$ " First cycle RMS value) [A]	18,6			
Inrush current [A]	4,52			
Rated frequency [Hz]	50 / 60			
cos phi	0.30 inductive ... 0.30 capacitive			
Number of feed-in phases	3			
Distortion factor (THD) [%]	2.22			
General electrical data				
Max. efficiency [%]	98.0	98.0	98.0	97.9
European efficiency [%]	97.5	97.6	97.7	97.6
Self consumption: night [W]	1.5			
Feed-in starts at [W]	20			
Circuit design	Transformerless			
Protection class / over voltage category	3 / III			
Grid monitoring	Country-specific			

Table 1: Electrical data

## 4.2 Mechanical data

	12.0 TL3	14.0 TL3	18.0 TL3	20.0 TL3
Display	Graphical LCD, 3 LEDs			
Controls	4-way button, 2 buttons			
Interfaces	Ethernet, USB, RS485, S0, Digital output "Inverter off"			
Fault signal relay	Potential-free NO contact, 30 V/1 A			
AC connections: PCB terminal	PCB terminals inside the unit (max. cross section: 16 mm <sup>2</sup> )			
AC connections: Cable connection	Cable connection via M40 cable fitting			
DC connections	8 (2 x 4) MC-4-compatible plug connections			
Ethernet connection: Cable connection	Cable connection via M25 cable fitting			
Ambient temperature range [°C]	-25 ... +60, power derating from +50			-25 ... +60, derating from +35
Humidity range (non-condensing) [%]	0 ... 95			
Maximum installation elevation [m above sea level]	2,000			
Temperature monitoring	Yes			
Cooling (free convection (K)/fan (L))	L			
Protection rating according to EN 60529	IP65			
Degree of contamination	2			
Noise emission [dB(A)]	< 52			
DC isolator switch	Built-in			
Housing	Cast aluminium			
H x W x D [mm]	Approx. 690 x 420 x 200			
Total weight [kg]	40	40	44	44
CE conformity	yes			

Table 2: Mechanical data

\* The DC starting voltage can be set in the menu if needed.

## 4.3 Identification

### Identifying the unit

You will find the name plate with product-specific data for service and other requirements specific to installation on the right side panel of the inverter. This data includes:

- Product name
- Part no.
- Serial no.
- Date of manufacture
- Technical Data
- Disposal information
- Certification marking, CE marking.





<b>KACO</b> 	<b>Typ / Type</b>	<b>Powador 12.0 TL3 - INT</b>
KACO new energy GmbH Carl-Zeiss-Str. 1 74172 Neckarsulm MADE IN GERMANY	Seriennummer / serial no.	*
	Artikelnummer / part no.	70211503
		
Max. Eingangsleistung / input power DC	12000 W	
Max. Eingangsstrom / input current DC / Isc PV	2 x 18,6 A   2 x 22,32 A	
Max. Eingangsspannung / input voltage DC	1000 V	
Min. Eingangsspannung / input voltage DC	200 V	
MPP-Spannungsbereich / MPP voltage range DC	280 - 800 V	
Umgebungstemperatur / ambient temperature	-25 °C ... +60 °C	
Schutzklasse I Schutzart / protection class I protection	1 / IP65	
Cos phi	0,8 ind - 0,8 cap	
Nennspannung / rated output voltage AC	400 V / 230 V 3/N/PE	
Frequenz / rated frequency	50 / 60 Hz	
Nennleistung DE / rated output power AC INT	10000 VA	
Nennstrom DE / rated output current AC INT	3 x 14,5 A	
Netzüberwachung / grid monitoring	VDE V 0128-1-1 + A1 / country specific	
Jahr / year	Q1 / 2016	
galvanisch nicht getrennt / no galvanic isolation		
Dep. on country settings all specific requirements are met, details see manual.	 	

Figure 4: Name plate

## 5 Transportation and Delivery

### 5.1 Delivery

Every inverter leaves our factory in proper electrical and mechanical condition. Special packaging ensures that the units are transported safely. The shipping company is responsible for any transport damage that occurs.

#### Scope of delivery

- 1 inverter
- 1 wall bracket
- 1 installation kit
- 1 set of documentation (DE, EN, quick start guide in other languages)

#### Checking your delivery

1. Inspect your inverter thoroughly.
2. Immediately notify the shipping company in case of the following:
  - Damage to the packaging that indicates that the inverter may have been damaged
  - Obvious damage to the inverter
3. Send a damage report to the shipping company immediately.

The damage report must be received by the shipping company in writing within six days following receipt of the inverter. We will be glad to help you if necessary.

### 5.2 Transportation

#### CAUTION

##### Impact hazard, risk of breakage to the inverter

- › Pack the inverter securely for transport.
- › Carefully transport the inverter using the transportation pallet.
- › Do not subject the inverter to shocks.

For safe transportation of the inverter, use the holding openings in the carton.

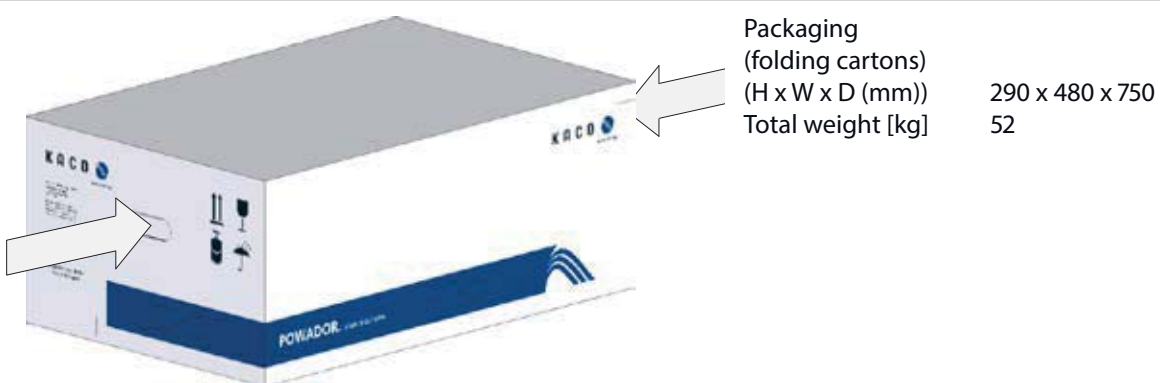

Figure 5: Transportation of the inverter

Table 3: Dimensions and weight

## 6 Mounting



### DANGER



#### Risk of fatal injury from fire or explosions

Fire caused by flammable or explosive materials in the vicinity of the inverter can lead to serious injuries.

- › Do not mount the inverter in an area at risk of explosion or in the vicinity of highly flammable materials.

### Installation location

- As dry as possible, climate-controlled, the waste heat must be dissipated away from the inverter
- Unobstructed air circulation
- When installing the unit in a control cabinet, provide forced ventilation for sufficient heat dissipation
- Access to the inverter must also be possible without additional tools
- For outdoor installation, fit the inverters in such a way to ensure that they are protected against direct sunlight, moisture - and dust penetration
- For easy operation, ensure during installation that the display is slightly below eye level.

### Wall surface

- With sufficient load-bearing capacity
- Accessible for installation and maintenance
- Made from heat-resistant material (up to 90 °C),
- Flame resistant
- Minimum clearances to be observed during assembly: see Figure 10 on page 15.



#### NOTE

##### Access by maintenance personnel for service

Any additional costs arising from unfavourable structural or mounting conditions shall be billed to the customer.

### CAUTION

**Property damage due to gases that have an abrasive effect on surfaces when they come into contact with ambient humidity caused by weather conditions.**

**The inverter housing can be severely damaged by gases (ammonia, sulphur, etc.) if it comes into contact with ambient humidity caused by weather conditions.**

If the inverter is exposed to gases, it must be mounted so that it can be seen at all times.

- › Perform regular visual inspections.
- › Immediately remove any moisture from the housing.
- › Take care to ensure sufficient ventilation of the inverter.
- › Immediately remove dirt, especially on vents.
- › Failure to observe these warnings may lead to inverter damage which is not covered by the KACO new energy GmbH manufacturer warranty.



#### NOTE

##### Power reduction due to heat accumulation.

If the recommended minimum clearances are not observed, the inverter may go into power regulation mode due to insufficient ventilation and the resulting heat build-up.

- › Maintain minimum clearances.
- › Provide for sufficient heat dissipation.

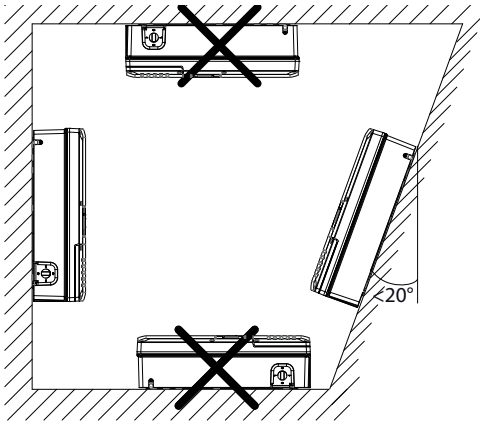

Figure 6: Instructions for wall mounting

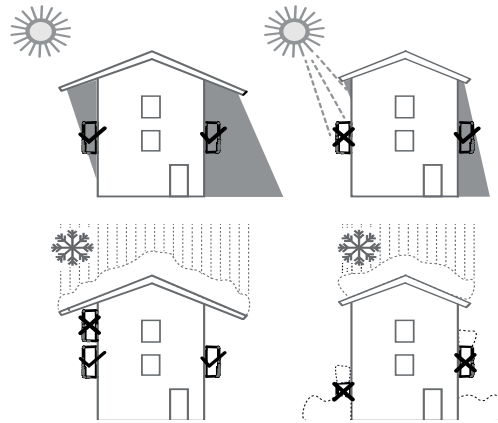

Figure 7: Inverter for outdoor installation

**CAUTION**

**Use suitable mounting parts.**

- › Use only the supplied mounting parts.
- › Mount the inverter upright on a vertical wall only.
- › For a free-standing mounting an incline of  $20^\circ$  is allowed.

**6.1 Unpacking**

**CAUTION**

**The inverter is very heavy – risk of injury!**



- › Observe the weight of the inverter during transport.
- › Select suitable mounting location and mounting base.
- › Use mounting material corresponding to or included with the base for mounting the inverter.
- › Transport and install the inverter with at least 2 persons.

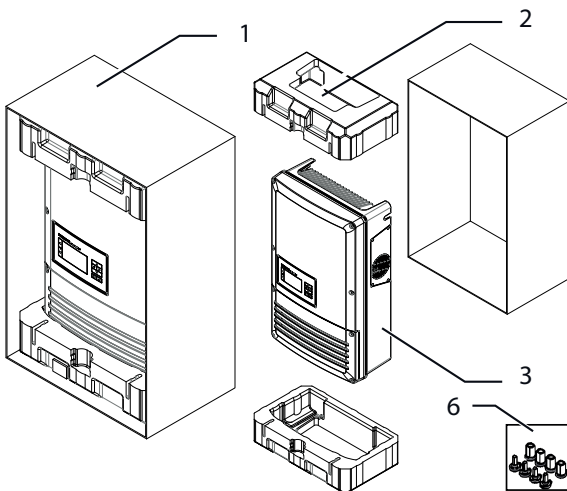

Figure 8: Unpack inverter

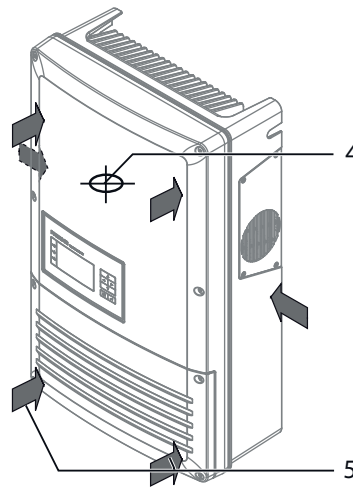

Figure 9: Lifting the inverter

**Key**

1	Carton	4	Centre of gravity of the inverter
2	Protective packaging	5	Positions for lifting
3	inverter	6	Protective covers

**Unpack inverter**

1. Open carton at the front.
  2. Remove installation material and documentation.
  3. Slide the unit aside the housing out of the carton.
  4. Remove upper and lower protective packaging from housing.
  5. Place the protective packaging back into the carton.
  6. Lift the inverters to the intended positions (see Figure 9).
- » Continue mounting the inverter.

**6.2 Installing the unit**

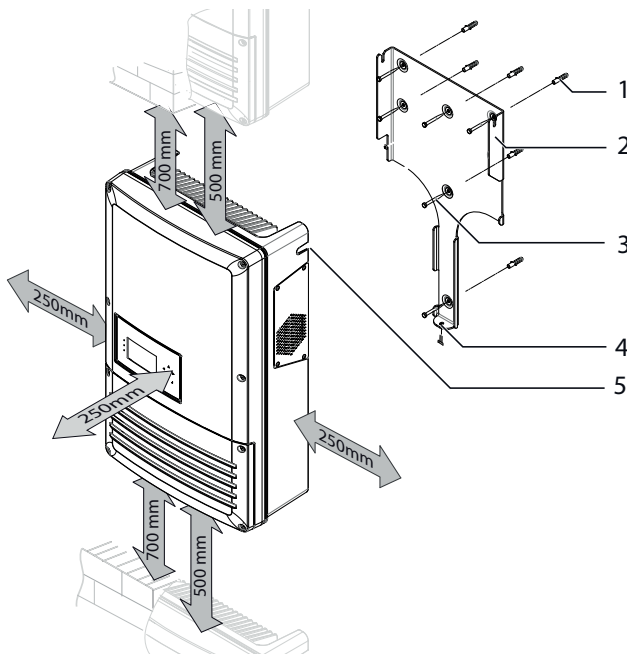

Figure 10: Minimum clearances

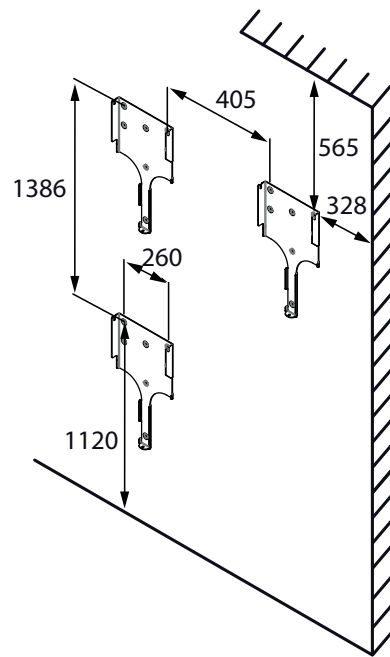

Figure 11: mounting plate

**Key**

1	Fixings for mounting	4	Detachment protector
2	Wall bracket	5	Suspension brackets (back of housing)
3	Screws for mounting		

**Installing the mounting plate and the unit**

1. Mark the positions of the drill holes using the slots in the wall holder.  
NOTE: The minimum clearances between two inverters, or the inverter and the ceiling/floor have already been taken into account in the diagram.
  2. Fix mounting plate to the wall with the supplied mounting fixtures.  
Make sure that the mounting plate is oriented correctly.
  3. Hang the inverter on the wall holder using the suspension brackets on the back of the housing.
  4. Fix the inverter with the enclosed screws to the detachment protector at the connection area.
- » The mounting of the inverter is complete. Continue with the installation.

 **Authorised electrician**

## 7 Electrical connection

 **DANGER**

**Lethal voltages are still present in the terminals and cables of the inverter even after the inverter has been switched off and disconnected.**

Severe injuries or death will occur when touching the cables and terminals in the inverter.



- › Only appropriately qualified and authorised electricians may open and install the inverter.
- › Observe all safety regulations and the current technical connection specifications from the relevant power supply company.
- › The inverter must be mounted in a fixed position before being connected electrically.
- › Disconnect the AC and DC side.
- › Secure the inverter against reconnection.
- › Ensure that the AC and DC sides are completely voltage free.

### 7.1 Preparing the AC connection

#### 7.1.1 Open connection area

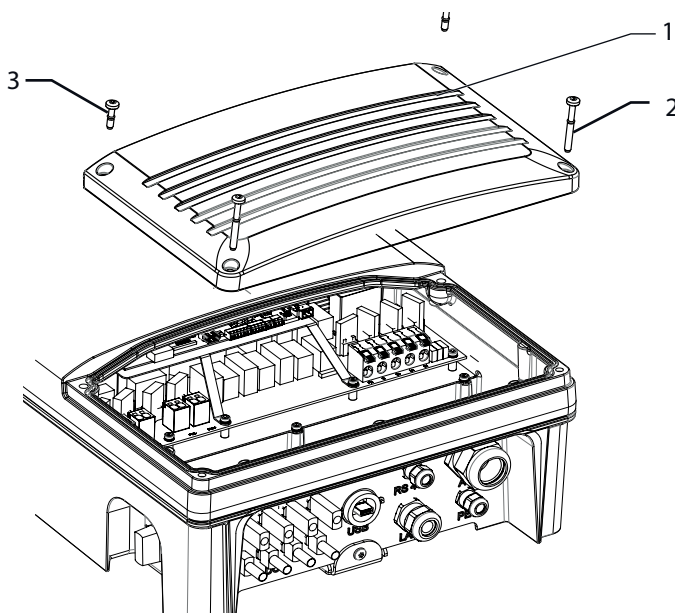

Figure 12: Connection area: Open connection cover

#### Key

1	Connection cover	3	Screws for mounting (short)
2	Screws for mounting (long)		

#### Open connection area

- You have mounted the inverter on the wall.
- 1. Unscrew the four Torx screws on the front side of the connection cover (blue).
- 2. Pull down the connection cover.
- » Make the electrical connections.



#### NOTE

Remove only the connection cover (blue). Opening the housing cover (grey) will invalidate the warranty.



**⚠️ Authorised electrician**

**EN**

### 7.1.2 Surveying the connection area

Make the connection to the PV generator via the plug connectors and the grid connection via the PCB terminals in the connection area of the inverter.

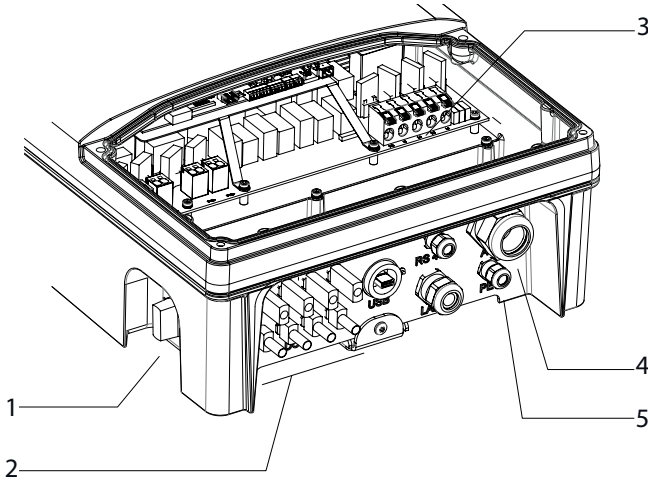

Figure 13: Connection area: Electrical connection

**Key**

1	DC isolator switch	3	AC connection terminals
2	8 (2 x 4) MC4-compatible DC plug connector for PV generator	4	Cable fitting (M40) for AC connection
		5	Cable fittings (M16) for housing ground connection

### 7.1.3 Cable and fuse requirements



**NOTE**

Select the following specifications in accordance with the following master conditions:

- Country specific installation standards
- Line length
- Type of line installation
- Local temperatures

	AC connection	DC connection
Max. conductor cross-section without wire sleeves	16 mm <sup>2</sup>	dependent on the plug that is used
Max. conductor cross-section with wire sleeves	10 mm <sup>2</sup>	
Length of insulation to be stripped off	18 mm	

Table 4: Recommended conductor cross-section

	AC connection	DC connection
Overvoltage protection		no
Overvoltage conductor (SPD)		-
String fuses	-	To be provided externally on-site
Combiner box	-	To be provided externally on-site
Protection class	3	3
Overvoltage category	III	II

Table 5: Integrated and recommended protective devices

 **Authorised electrician**

Model	Conductor cross-section	Fuse protection: gL safety fuses or comparable automatic circuit breakers
Powador 12.0 TL3 / 14.0 TL3	6.0 mm <sup>2</sup>	25 A for 4.0 mm <sup>2</sup> conductor cross-section
Powador 18.0 TL3 / 20.0 TL3	6.0 mm <sup>2</sup>	32 A for 6.0 mm <sup>2</sup> conductor cross-section

Table 6: Recommended conductor cross-sections and fuse protection of NYM cables

## 7.2 Connection to the power grid

The power connection wires are connected on the right of the connection area (see Figure 13 on page 17).

 **DANGER**
**Danger to life from electric shock!**

Severe injury or death will result if the live connections are touched.



- › Switch off all power sources to the inverter before you insert the grid power cable into the unit.
- › Make sure that the device is isolated from the public power supply and the system power supply before starting work.

### NOTE



If the cable impedance is high (i.e. long grid-side cables), the voltage at the grid terminals of the inverter will increase during feed-in to the grid. The inverter monitors this voltage. If it exceeds the country-specific grid overvoltage limit value, the inverter switches off.

- › Ensure that the conductor cross-sections are sufficiently large or that the cable lengths are sufficiently short.

### Making the grid connection

- ↻ Use cables with five wires (L1, L2, L3, N, PE).
- 1. Unscrew the cable fitting.
- 2. Remove the outer cladding of the AC cables.
- 3. Insert the AC cables through the cable fitting into the connection area.
- 4. Strip the insulation from the AC cables.
- 5. Open the locks for the PCB terminals.
- 6. Connect the cables in accordance with the label on the PCB terminals (Figure 14 on page 18).
- 7. Close the locks for the PCB terminals.
- 8. Check secure fit of all connected cables.
- 9. Tighten the cable fitting.
- » The inverter is now connected to the power grid.

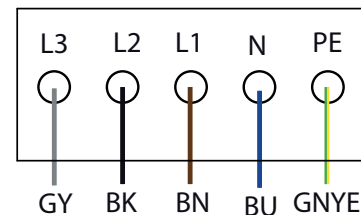

Figure 14: AC connection terminals

### NOTE



An AC-side disconnection unit must be provided during the final installation stage. This cut-off mechanism must be installed so that it can be accessed at any time without obstruction.

### NOTE



If a residual current circuit breaker is necessary due to the installation specification, a type A residual current circuit breaker must be used.

If an A-type RCD is used, the insulation threshold value in the “parameter” menu **must be over (>) 200kOhm**. (Chapter 8.3 on Page 40).

For questions regarding the appropriate type, please contact the installer or our KACO new energy customer service.

 **Authorised electrician**

## 7.3 Preparing the DC connection

### 7.3.1 Configuring the DC plug connector

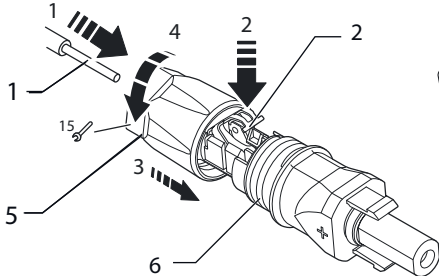

Figure 15: Insert wires

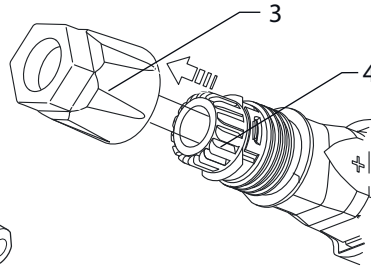

Figure 16: Slide insert into sleeve

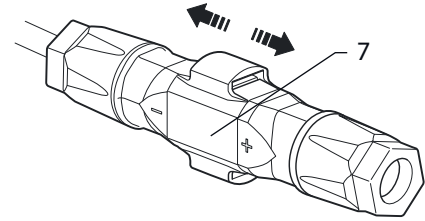

Figure 17: Check fastening

#### Key

1	Wire for DC connection	5	cable fitting
2	Spring	6	Contact plug
3	Insert	7	Coupling
4	Sleeve		

#### Configuring the DC plug connector

**NOTE:** Before proceeding with the isolation ensure that you don't cut any individual wires.

1. Isolate wire for DC connection by 15 mm.
2. Insert isolated wire with twisted ends carefully up to the end stop.

**NOTE:** Wire ends must be visible in the spring.

3. Close the spring so that the spring latches.
  4. Slide insert into sleeve.
  5. Tighten cable fitting with the help of a 15 mm fork wrench applying a torque of 2 Nm.
  6. Join insert with contact plug.
  7. Check latch by lightly pulling on the coupling.
- » Make the electrical connection.



#### NOTE

The permissible bending radius of at least 4x the cable diameter should be observed during installation. Excessive bending force may negatively impact the protection rating.

- › All mechanical loads must be absorbed in front of the plug connection.
- › Rigid adaptations are not permitted on DC plug connectors.

### 7.3.2 Checking the PV generator for a ground fault

 **DANGER**

#### Danger to life from electric shock!



Severe injury or death will result if the live connections are touched. When there is solar radiation, DC voltage will be present at the open ends of the DC cables.

- › Only touch the PV generator cables on the insulation. Do not touch the exposed ends of the cables.
- › Avoid short circuits.
- › Do not connect any strings with a ground fault to the unit.

 **Authorised electrician**
**Checking the PV generator for a ground fault**

1. Determine the DC voltage between:
  - protective earth (PE) and the positive cable of the PV generator
  - protective earth (PE) and the negative cable of the PV generator

If stable voltages can be measured, there is a ground fault in the DC generator or its wiring. The ratio between the measured voltages gives an indication as to the location of this fault.

2. Rectify any faults before taking further measurements.
3. Determine the electrical resistance between:
  - protective earth (PE) and the positive cable of the PV generator
  - protective earth (PE) and the negative cable of the PV generator

In addition, ensure that the PV generator has a total insulation resistance of more than 2.0 MOhm, since the inverter will not feed in if the insulation resistance is too low.

4. Rectify any faults before connecting the DC generator.

**NOTE**

The threshold value from which the insulation monitor reports a fault can be set in the "Parameter" menu.

### 7.3.3 Designing the PV generator

**NOTE**

Connected PV modules must be dimensioned for the DC system voltage in accordance with IEC 61730 Class A, but at least for the value of the AC grid voltage

	$P_{max}$	$I_{rated\ max.}$ MPP tracker	$I_{SC\ max.}$ MPP tracker
MPP tracker	<20 kW	<18,6 A	<22,4 A

## 7.4 Connecting the PV generator

Connect the PV generator to the 4 DC positive and the 4 DC negative connection plugs on the underside of the housing (see Figure 18 on page 21). Note the wiring examples given below. The inverter detects these typical configurations automatically. In individual cases, you need to set the selected DC connection after installation in the menu.

**DANGER**
**Risk of fatal injury due to contact voltages.**

Removing the plug connection before disconnecting the inverter from the PV generator may lead to injuries and damage the unit.

- › During installation: Electrically disconnect the DC positive and DC negative from the protective earth (PE).
- › Remove the plug connector.

**CAUTION**
**Damage to the device in case of faulty configuration of the DC connector.**

A faulty configuration of the DC connector (polarity +/-) causes equipment damages in the DC connection if it is connected permanently.

- ☞ Please check polarity (+/-) of the DC connector before connecting the DC generator
- ☞ The DC voltage must not exceed 1000V at any time.

 **Authorised electrician**

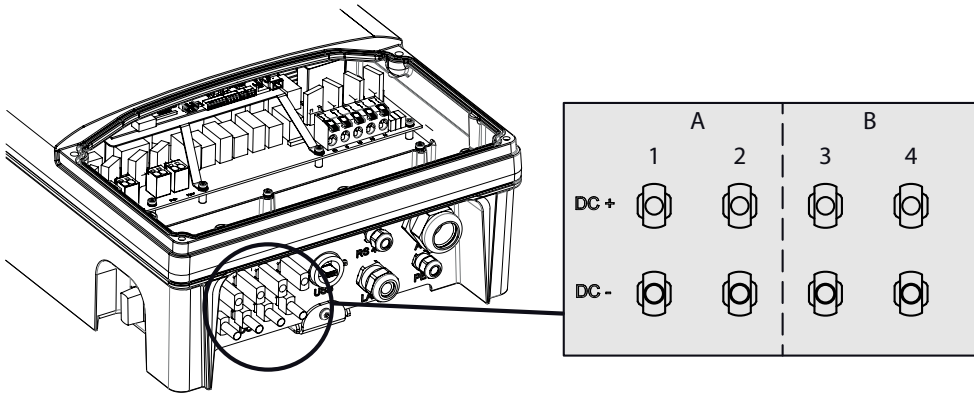

Figure 18: Connections for DC positive and DC negative

**Key**

A	MPP tracker A	B	MPP tracker B
1.2	DC-Plus/DC-Minus-Connections to MPP tracker A	3.4	DC-Plus/DC-Minus-Connections to MPP tracker B

**7.4.1 Maximum input power**

The input power of the inverter is limited only by the maximum rated current of 18.6 A per input. This causes the maximum input power per path to increase with the input voltage.



**NOTE**

The overall power of the unit continues to be limited. If one input is connected to more than  $P(D-C_{max})/2$ , the maximum input power of the second input decreases accordingly. Take care that the maximum input power is not exceeded.

**7.4.2 Connection**

 **DANGER**



**Risk of fatal injury due to electric shock (electric arc)!**

**Wrong assignment of MPP trackers will seriously damage the inverter**

Severe injury or death will result if the live connections are touched.

- › Make sure that each MPP tracker can be disconnected from all poles.
- › Observe recommended standard connection.

• **1.) Standard connection - Two generators each on one MPP tracker**

Equal MPP voltages must be applied to input 1 and 2, as well as inputs 3 and 4. The MPP voltages of the two DC paths can be different. They are tracked by separate, independently operating MPP trackers (MPP trackers A and B). ( $n_1=n_2, n_3=n_4$ ).

• **2.) Unconnected inputs for unused MPP trackers**

If one of the MPP trackers (A or B) is not used, then it must be short-circuited, otherwise faults can occur in the self-test of the unit and the feed-in operation is not guaranteed. The short-circuiting of an MPP tracker does not result in the device being damaged.

 **Authorised electrician**

EN

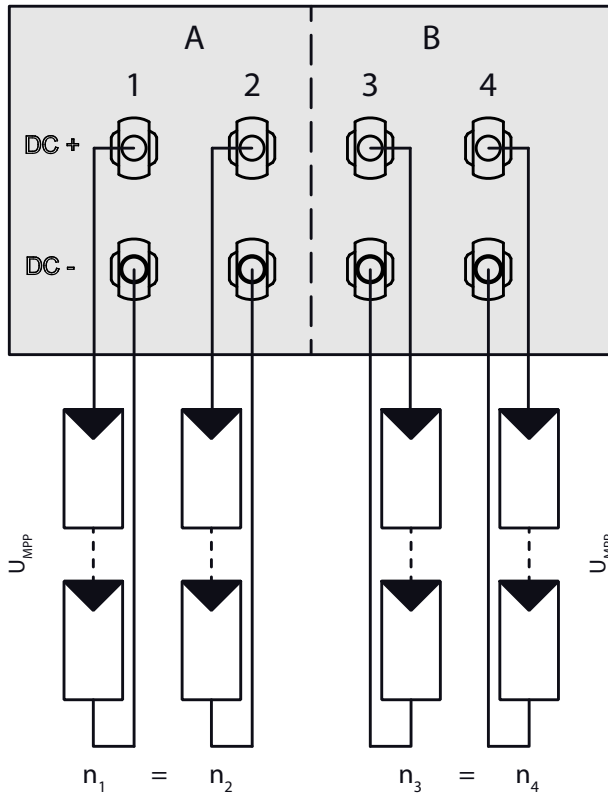

Figure 19: Recommended standard connection

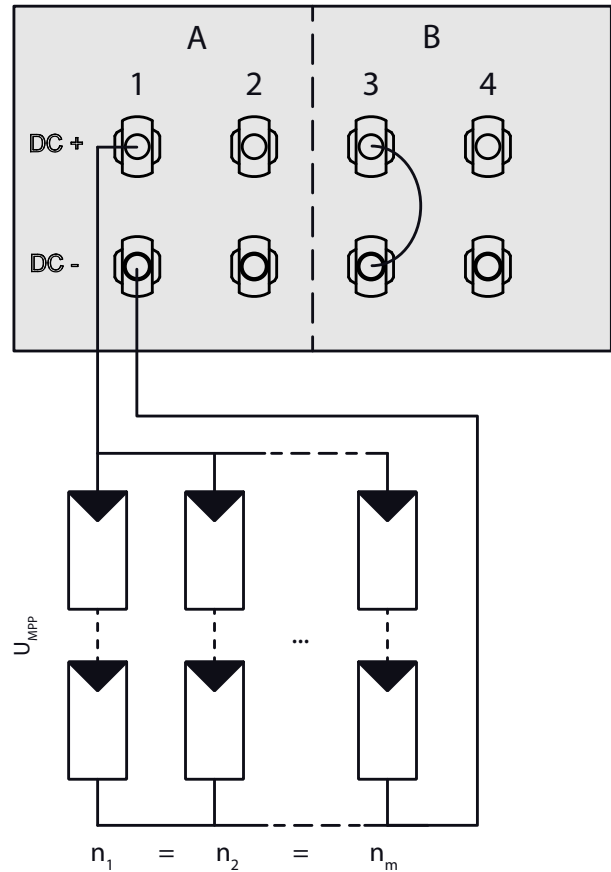

Figure 20: Parallel input with Y-adaptor, short-circuits the unused MPP Tracker B

**Electrical data**

Connecting the DC inputs	Number of modules per string: $n_1=n_2, n_3=n_4$	Number of modules per string: $n_1=n_2=n_m$
$P_{max}$	per string $< 0.5 * \text{max. recommended PV generator power}$ MPP tracker A+B together $< \text{max. recommended PV generator power}$	per string $< 0.5 * \text{max. recommended PV generator power}$ $P_{max}$ on the MPP tracker used $< \text{max. power per tracker}$
$I_{max}$	Amperage per tracker $< \text{max. rated current} < \text{max. rated current (DC)}$	

 **DANGER**

**Danger to life from electric shock!**



- Severe injury or death will result if the live connections are touched. When there is solar radiation, DC voltage will be present at the open ends of the DC cables.
- › Do not touch the exposed ends of the cables.
  - › Avoid short circuits.

**⚠️ Authorised electrician**
**Connecting the PV generator**

1. Remove protective caps from the DC connection plugs.
  2. Connect PV generator to the DC plug connectors on the underside of the housing.
  3. Ensure that the unused plug connectors are sealed with protective caps.
- » The inverter is connected to the PV generator.

## 7.5 Grounding the housing

**⚠️ DANGER**
**Dangerous voltage due to two operating voltages!**

Severe injuries or death may occur if the cables and terminals in the device are touched.

The discharge time of the capacitors is up to 5 minutes.



- › Only appropriately qualified and authorised electricians may open and maintain the inverter.
- › Before opening the unit: Disconnect the PV generator and grid and wait at least 5 minutes.
- › Establish ground connection under all circumstances before connecting the supply circuit.
- › Make sure that the device is isolated from the public power supply and the system power supply before starting work.

An optional grounding of the housing is possible at the grounding point provided for that purpose in the connection area of the inverter. Please observe any national installation regulations in this regard.

Ground the housing of the inverter, if necessary, at the grounding point provided for that purpose in the connection field of the inverter

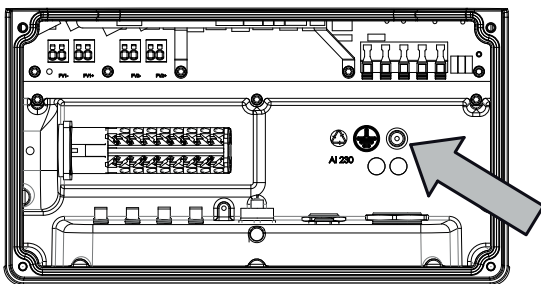

Figure 21: Grounding point in the connection area

**Grounding the housing**

1. Detach cable fitting for grounding the housing.
  2. Remove the outer cladding from the grounding cable.
  3. Insert the grounding cable through the cable fitting into the connection area.
  4. Remove the insulation from the grounding cable.
  5. Furnish the stripped cable with an M4 ring cable lug.
  6. Screw the ring cable lug to the grounding point with an M4/TX30 screw.
  7. Check that the cable is secure.
- » Tighten the cable fitting.

 **Authorised electrician**

## 7.6 Connecting the interfaces

All interfaces are located on the connection circuit board behind the cover for the connection area. Use the cable fittings and plug connections provided (see Figure 22 on page 24).

### CAUTION

#### Damage to the unit from electrostatic discharge

Components inside the unit can be damaged beyond repair by static discharge.

- ☞ Note the ESD protective measures.
- ☞ Earth yourself before touching a component by touching a grounded object.



### NOTE

When routing the interface connection cable, note that too little clearance to the DC or AC cables can cause interference during data transfer.

### 7.6.1 Determining the unit type

When connecting, be aware that the arrangement of the interface connections may be different from one equipment to another. Check the arrangement of the interface connections.

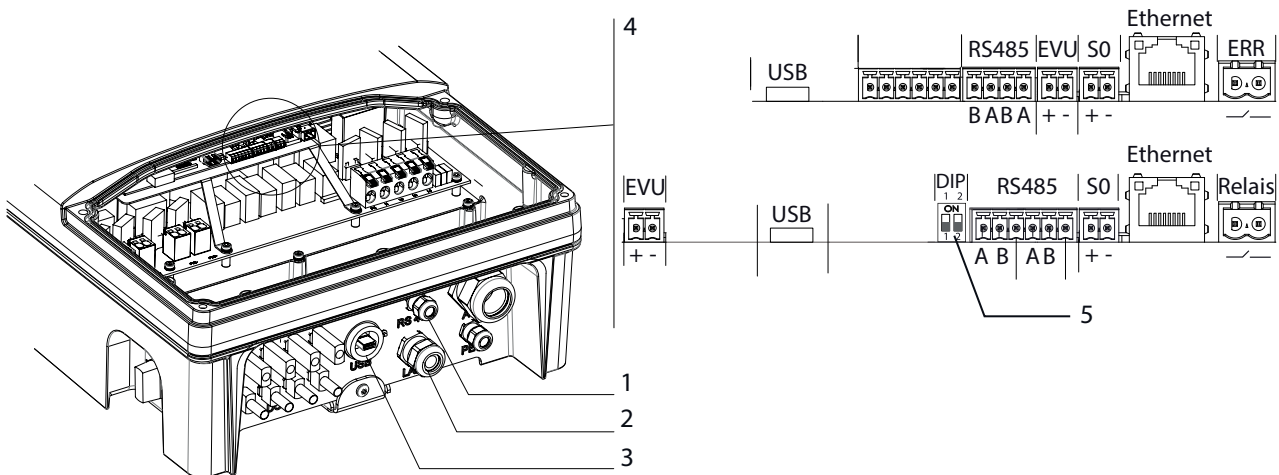

Figure 22: Connection area: Connection and assignment of the interfaces Top: variant 1. Bottom: variant 2.

#### Key

1	Cable fitting for RS485 connection cable	4	Interface connections / pin assignment
2	Cable fitting (M25) for Ethernet connection cable	5	DIP switch for terminating resistor Ra
3	USB interface with cover		

### **DANGER**

#### Danger to life from electric shock!

Severe injury or death may result from improper use of the interface connections and failure to observe protection class III.



- › The SELV circuits (SELV: safety extra low voltage) can only be connected to other SELV circuits with protection class III.



 **Authorised electrician**

## 7.6.2 Connecting the fault signal relay

The contact is designed as an N/O contact and is labelled "ERR" or "Relay" on the circuit board.

### Maximum contact load

DC	30 V/1 A
----	----------

### Connecting the fault signal relay

1. Unscrew the cable fitting.
2. Thread the connection cables through the cable fitting.
3. Attach the connection cables to the terminal clamps.
4. Tighten the cable fitting.

## 7.6.3 Connecting the Ethernet interface



### NOTE

The connection plug of an RJ45 cable is larger than the opening of an M25 cable fitting when it is installed. For this reason, remove the sealing insert before installation and thread the Ethernet cable outside of the cable fitting through the sealing insert.







### NOTE

Use a suitable category 5 network cable. The maximum length of a network segment is 100 m. Ensure that the cable is correctly assigned. The Ethernet connection of the inverter supports auto-sensing. You can use both crossed and 1:1 protectively-wired Ethernet connection cables.

### Connecting an Ethernet cable to the inverter

1. Loosen and remove the cover of the cable fitting (see Figure 22 on page 24).
2. Remove the sealing insert.
3. Thread the connection cable through the cover of the cable fitting and the sealing insert.
4. Insert the sealing insert into the cable fitting.
5. Connect the connection cable to the Ethernet interface (see Figure 22 on page 24).
6. Attach and tighten the cover of the cable fitting.

### Connecting the inverter to the network

-  Connect the Ethernet cable to the inverter.
-  Configure the Ethernet interface in the configuration menu.
-  Connect the Ethernet cable to the network or a computer.
-  Configure the Ethernet settings and the web server in the Settings/Network menu.

## 7.6.4 Connecting the S0 output

An S0 pulse output is located on the communication board. Use this output to control accessories such as a large display, for example. The pulse rate of the output is adjustable.

### Connecting the S0 output

1. Unscrew the cable fitting (see Figure 22 on page 24).
2. Thread the connection cables through the cable fitting.
3. Attach the connection cables to the terminal clamps.
4. Tighten the cable fitting.

 **Authorised electrician**

### 7.6.5 Connecting the RS485 bus

**NOTE**



Ensure that the DATA+ and DATA- wires are properly connected. Communication is not possible if the wires are reversed.

Different manufacturers do not always interpret the standard on which the RS485 protocol is based in the same way. Note that the wire designations (DATA- and DATA+) for wires A and B may vary from one manufacturer to another.

#### Wiring diagram

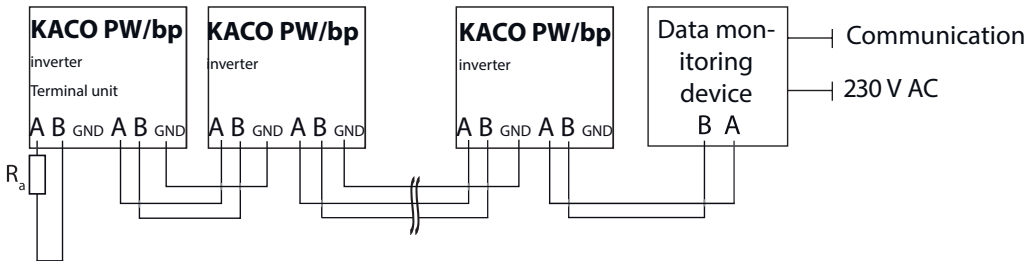

Figure 23: RS485 interface wiring diagram

Properties of the RS485 data line	
Maximum length of the RS485 bus line	The maximum permitted length of the RS485 bus is 1200 m. This length can be reached only under optimum conditions. Cable lengths exceeding 500m generally require a repeater or a hub.
Maximum number of connected bus devices	30 inverters + 1 data monitoring unit
Data line	Twisted, shielded. Recommendations: LI2YCYv (twisted pair) black for laying cable outside and in the ground, 2 x 2 x 0.5 LI2YCY (twisted pair) grey for dry and damp indoor spaces, 2 x 2 x 0.5

#### Connecting the RS485 bus

- ☞ To prevent interference during data transmission:
  - ⌚ Observe the wire pairing when connecting DATA+ and DATA- (see Figure 24).
  - ⌚ Do not lay RS485 bus lines in the vicinity of live DC/AC cables.
1. Connect the connection cable to the corresponding connection terminals (Figure 22 on page 24).
  2. The following must be connected to all inverters and to the data monitor unit in the same way:
    - Wire A (-) to wire A (-)
    - Wire B (+) to wire B (+) and
    - GND with GND (see Figure 23 on page 26)
  3. Tighten the cable fitting.
  4. Activate the terminating resistor on the terminal unit.

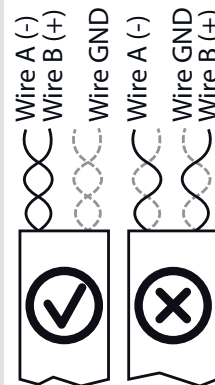

Figure 24: Assignment of twisted-pair wires

 **Authorised electrician**
**Variant 1: activate the terminating resistor in the settings menu**





1. Open the menu.
2. Select "Settings"/"Interface."
3. Activate terminating resistor in the "Bus termination" menu entry.
4. Confirm with "Enter".

**variant 2. activate the terminating resistor with the switches on the circuit board**

Activate the terminating resistor in the inverter that represents the terminal unit within your wiring diagram.

**NOTE**

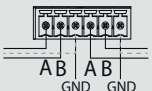
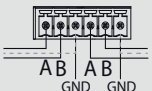
Always activate the RS485 terminating resistor in the terminal using DIP switch 2.  
For grounding the screen use the terminals GND.

	Sample connection	DIP switch	Switch 1	Switch 2
The inverter is the terminal unit: 			OFF	ON
The inverter is not the terminal unit: 			OFF	OFF

**7.6.6 Connecting "Inverter Off" (optional)**

**NOTE**

The Powador-protect digital output can only be used with suitable KACO inverters. When using devices from other manufacturers or in combination with KACO inverters, bus coupler circuit-breakers as a minimum must be used for shutting down devices from other manufacturers.

**Connecting and activating "INV OFF" digital input**

- ⊖ Can only be used with suitable KACO inverters.
1. Connect wire A (+) to the terminal marked "INV+" on the first inverter via the "DO1" terminal of the Powador-protect.
  2. Connect wire B (-) to the terminal marked "INV-" on the first inverter via the "GND" terminal of the Powador-protect.
  3. Connect the other inverters to one another as follows:
    - Wire A (+) to wire A (+) and
    - wire B (-) to wire B (-).
  4. Tighten the cable fitting.
  5. After commissioning: Activate the support for Powador protect in the parameter menu under the "Powador-protect" menu item.

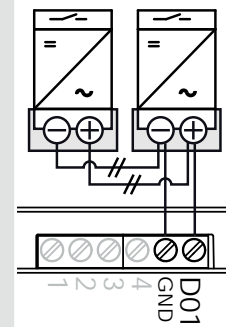

Figure 25: Powador-protect

**7.7 Sealing the connection area**

1. The requirements of protection rating IP65 are met by closing the unused cable fittings with blind caps.
2. Place the connection cover on the connection area of the inverter.
3. Screw in the four Torx screws on the front side of the connection cover (blue).

 **Authorised electrician**

## 7.8 Switching on the device

### **DANGER**



**Lethal voltages are still present in the terminals and cables of the inverter even after the inverter has been switched off and disconnected.**

Severe injuries or death will occur when touching the cables and terminals in the inverter.  
Only appropriately qualified and authorised electricians may start up the inverter.

### **CAUTION**



**Risk of burns from hot housing components.**

The housing surface and the heat sink can adopt a surface temperature of 75° in operation.

- › Do not touch the housing surface or heat sink during and immediately after operation.
- › Allow the device to cool down before touching the housing surface.

FR

### **Attachment of safety label in accordance with UTE C 15-712-1**

The code of practice UTE C 15-712-1 requires that, upon connection to the French low-voltage distribution network, a safety sticker showing a warning to isolate both power sources when working on the device must be attached to each inverter.

- ☞ Attach the provided safety sticker visibly to the outside of the inverter housing.

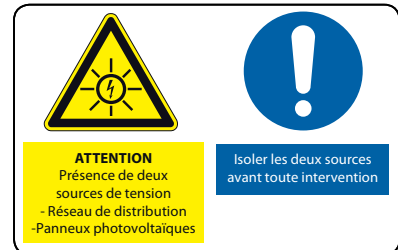

- ☞ The inverter has been mounted and electrically installed.
  - ☞ The PV generator supplies a voltage above the configured start voltage.
1. Connect the grid voltage using the external circuit breakers.
  2. Connect the PV generator using the DC isolator switch (0 → 1).
- » The inverter begins to operate.
  - » During initial start-up: Follow the instructions of the New Connection Wizard.

## 8 Configuration and Operation

### 8.1 Controls

The inverter has a backlit LCD as well as three status LEDs. The inverter is operated using six buttons.

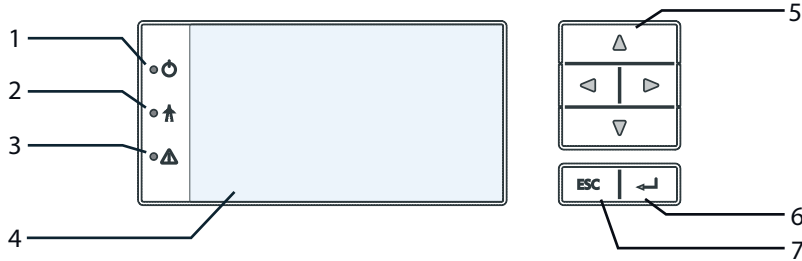

Figure 26: Control panel

**Key**







1	"Operating" LED	5	4-way button
2	"Feed-in" LED	6	"Enter" key
3	"Fault" LED	7	"ESC" key
4	LCD		

#### 8.1.1 LED indicators







The 3 LEDs on the front of the inverter show the different operating states. The LEDs can display the following states:



The LED indicators show the following operating status:

Operating status	LEDs	Display	Description
Start			The green "Operating" LED is illuminated if an AC voltage is present, (independently of the DC voltage).
Feed-in start			The green "Operating" LED is lit. The green "Feed-in" LED is illuminated after the country-specific waiting period*. The unit is ready to feed in, i.e. is on the grid. You can hear the grid relay switch on.
Feed-in operation			The green "Operating" LED is lit. The green "Feed-in" LED is illuminated. The "Feed-in" icon appears on the LC display. The unit feeds into the grid.

\* The waiting period ensures that all network parameters are in the permissible ranges.

Operating status	LEDs	Display	Description
Non-grid feed mode	 	Status message	The display shows the corresponding message.
	 		
Fault	 	Fault message	The display shows the corresponding message. The red "Fault" LED is illuminated.

### 8.1.2 Graphical display

The graphical display shows measured values and data and allows the configuration of the inverter using a graphical menu. In normal operation, the backlighting is switched off. As soon as you press one of the control buttons, the backlighting is activated. If no button is pressed for an adjustable period of time, it switches off again. You can also activate or deactivate the backlighting permanently.

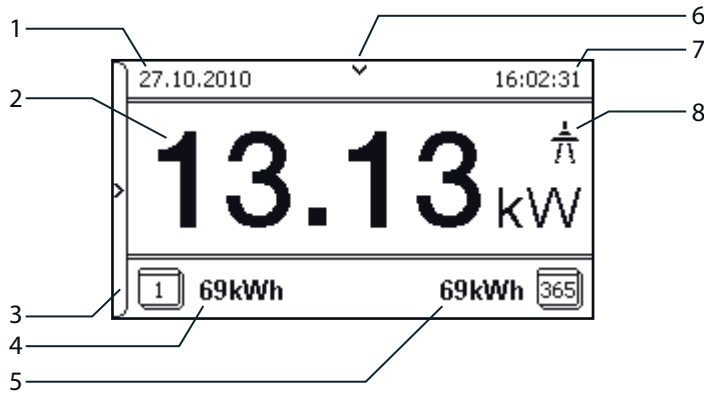

Figure 27: Desktop

**Key**

1	Current date	5	Annual yield
2	Current power	6	Status bar
3	Menu indicator	7	Current time
4	Daily yield	8	Feed-in indicator

After being switched on and after initial commissioning is complete, the inverter displays the start screen (the desktop). If you are in the menu and do not touch the control buttons for two minutes, the inverter returns to the desktop.

For initial commissioning, see section 8.2 on page 32

**NOTE**



Depending on the tolerances of the measuring elements, the measured and displayed values are not always the actual values. However, the measuring elements ensure maximum solar yield. Due to these tolerances, the daily yields shown on the display may deviate from the values on the grid operator's feed-in meter by up to 15%.

**NOTE**



Calculating efficiency by measuring the current and voltage values can lead to misleading results due to the tolerances of the measurement devices. The sole purpose of these measured values is to monitor the basic operation of the system.

### 8.1.3 Control buttons

The inverter is operated using the 4-way button and the Enter and ESC buttons.

#### Desktop

##### Opening the menu

- ↻ The inverter is operating.
- ↻ The LCD is showing the desktop.
- ☞ Press the right arrow button.
- » The main menu opens.



##### Displaying the daily output

- ↻ The inverter is operating.
- ↻ The LCD is showing the desktop.
- ☞ Press the down arrow button.
- » The LCD displays the daily yield in a diagram.
- ☞ To return to the desktop, press any button.

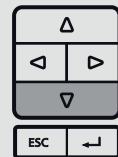

#### Inverter menu

##### Selecting a menu option

- ↻ You have left the desktop. The inverter displays the menu.
- ☞ Use the up and down arrow buttons.



##### Opening a menu item or a setting

- ☞ Use the right arrow button and the Enter button.



##### Jump to the next higher menu level/discard changes

- ☞ Press the left arrow button or the ESC button.



##### Selecting an option

- ☞ Use the right and left arrow buttons.

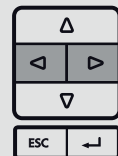

##### Changing an option/the value of an input field

- ☞ Use the up and down arrow buttons.



##### Saving changed settings

- ☞ Press the Enter button.

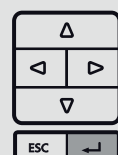

## 8.2 Initial start-up

When started for the first time, the inverter displays the configuration assistant. It takes you through the settings necessary for the initial start-up.



**NOTE**

After configuration is completed, the configuration assistant does not appear again when the inverter is restarted. You can then change the country setting only in the password-protected parameter menu. The other settings can still be changed in the Settings menu.



**NOTE**

The DC and AC power supply must be guaranteed during configuration. The sequence of the settings required for initial start-up is preset in the configuration assistant.

**Navigation**

- ☞ In order to select a setting, press the up and down buttons.
- ☞ To select the next menu item, press the Enter button.
- ☞ To return to the most recently selected menu item, press the ESC button.
- ☞ Set the required settings.
- ☞ Press the Enter button in the last menu item.

**Initial configuration**

- ☞ Select the menu language.
- ☞ Select the country of operation with grid type.
- ☞ Set the date and time.
- ☞ To store the set operator country and grid type permanently, confirm these settings with "Yes".
- » You have completed the initial configuration. The inverter begins to operate.

## 8.3 Menu structure

### 8.3.1 Display on the LCD

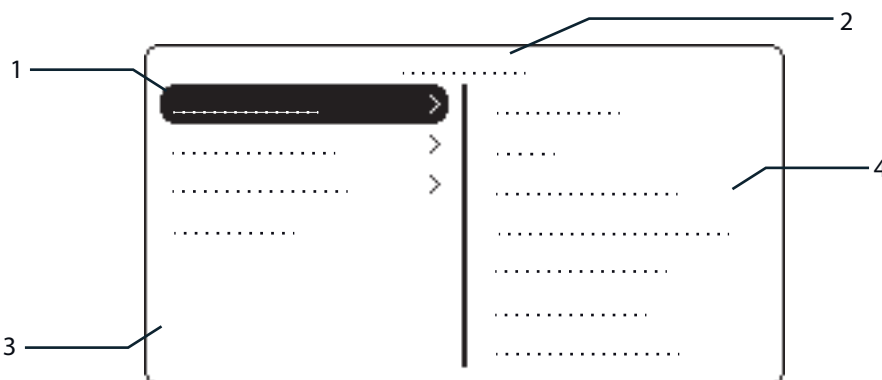

Figure 28: Main menu

**Key**

1	Selected menu item	3	Menu items of the active menu level
2	Name of the active menu level	4	Menu items of the next lower menu level



### 8.3.2 Menu structure



**NOTE**

The menu items displayed on screen are dependent on the country and network settings, and may vary according to the type of device.

**Icons used:**















	Menu level (0, 1, 2, 3)		Submenu available
	Display menu	<b>EN</b>	Country-specific setting
	Option menu	<b>FR-HTA</b>	Country and grid type-specific setting
	Password protected menu (password can be requested from KACO Service)		















Country-spec. setting	Menu level	Display/settings	Action in this menu/meaning
All countries	Desktop	<b>Desktop</b>	Press the right arrow button.
		<b>"Measurements" menu</b>	Open the menu: Press the right arrow button or the Enter button.
		<b>Generator</b>	Displays the DC-side voltage, amperage and power.
		<b>Grid</b>	Displays the AC-side voltage, amperage and power
		<b>Power control</b>	Displays the current value of the external power limitation by the grid operator.
		<b>cos-phi</b>	Indicates the status of the reactive power control.
		<b>Unit temperature</b>	Displays the temperature in the inverter housing.
		<b>Yield counter</b>	Displays the yield in kWh. Reset the counter using the "Reset" key.
		<b>Yield today</b>	Displays the cumulative yield for the current day.
		<b>Total yield</b>	Displays the total yield up to now.
		<b>CO2 savings</b>	Displays the calculated CO <sub>2</sub> savings (in kg).
		<b>Oper. hrs cntr</b>	Displays the duration of operation in hours. Reset the counter using the "Reset" key.
		<b>Oper. time today</b>	Displays the duration of operation on today's date.
		<b>Total oper. time</b>	Displays the total operating time.
		<b>Log data display</b>	Open the menu: Press the right arrow button or the Enter button. Measurement data can be transferred to a USB stick by selecting it and moving it.





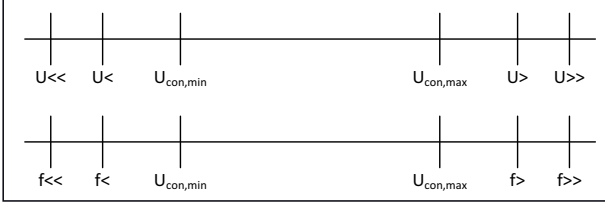

Country-spec. setting	Menu level	Display/settings	Action in this menu/meaning
All countries	1-2-3-4	<b>Day display</b>	<p>Displays the recorded operating data graphically.</p> <ol style="list-style-type: none"> <li>Select the measured value to be displayed.</li> </ol> <p>Supported measured values:</p> <ul style="list-style-type: none"> <li>Grid power P(grid)</li> <li>DC power per string P(PV) 1-2</li> <li>DC voltage per string U(PV) 1-2</li> <li>Unit temperature</li> </ul> <ol style="list-style-type: none"> <li>Select a day.</li> <li>Press the Enter button.</li> </ol> <p>» The display shows the selected data.</p> <p>☞ Press any button to return to the previous menu.</p>
	1-2-3-4	<b>Month display</b>	<p>Displays the recorded operating data graphically.</p> <ol style="list-style-type: none"> <li>Select a month.</li> <li>Press the Enter button.</li> </ol> <p>» The display shows the selected data.</p> <p>☞ Press any button to return to the previous menu.</p>
	1-2-3-4	<b>Year display</b>	<p>Displays the recorded operating data graphically.</p> <ol style="list-style-type: none"> <li>Select a year.</li> <li>Press the Enter button.</li> </ol> <p>» The display shows the selected data.</p> <p>☞ Press any button to return to the previous menu.</p>
	1-2-3-4	<b>CSV log data</b>	<p>☞ Open the menu: Press the right arrow button or the Enter button.</p>
	1-2-3-4	<b>Decimal separator</b>	<p>☞ Select decimal sign for export of saved operating data.</p>
	1-2-3-4	<b>Save to USB</b>	<p>In this menu, you can export the saved operating data to a connected USB flash storage device.</p> <p>🔄 You have connected a USB flash storage device to the inverter.</p> <ol style="list-style-type: none"> <li>Select the data to be exported (year, month or day).</li> <li>Press the Enter button.</li> </ol> <p>» The inverter writes the data to a connected USB flash storage device.</p>
All countries	1-2-3-4	<b>"Settings" menu</b>	<p>☞ Open the menu: Press the right arrow button or the Enter button.</p>
	1-2-3-4	<b>Language</b>	<p>☞ Select the desired language for the user interface.</p>
	1-2-3-4	<b>Def. total yield</b>	<p>☞ Set the total yield to any value. (If you want to continue the recording from the present value on a replacement unit).</p> <p>☞ Select the "Save" button and confirm with the Enter button.</p>







Country-spec. setting	Menu level	Display/settings	Action in this menu/meaning
All countries	1-2-3-4	<b>Interface</b>	<ul style="list-style-type: none"> <li>If the inverter is a terminal unit: Activate termination ("Bus termination" menu option)</li> <li>Assign a unique RS485 bus address ("RS485 address" menu option).</li> </ul> <p><b>NOTE:</b> The address must not be the same as that of any other inverter or a monitor device.</p>
	1-2-3-4	<b>S0</b>	<ul style="list-style-type: none"> <li>Open the menu: Press the right arrow button or the Enter button.</li> </ul>
	1-2-3-4	<b>Activation</b>	<ul style="list-style-type: none"> <li>Activate S0.</li> </ul>
	1-2-3-4	<b>Pulse rate</b>	<ul style="list-style-type: none"> <li>Set the pulse rate of the S0 connection.</li> </ul>
	1-2-3-4	<b>Priwatt</b>	<ul style="list-style-type: none"> <li>Open the menu: Press the right arrow button or the Enter button.</li> <li>Activate/deactivate the "Priwatt" function</li> </ul>
	1-2-3-4	<b>Activation mode</b>	<ul style="list-style-type: none"> <li>Select operating mode</li> </ul> <p><b>NOTE:</b> Re-activation depends on the operating mode selected and on the activation conditions.</p>
	1-2-3-4	<b>Monitoring time</b>	<ul style="list-style-type: none"> <li>Set time span during which the power threshold must be exceeded without interruption.</li> </ul>
	1-2-3-4	<b>Power threshold</b>	<ul style="list-style-type: none"> <li>Set power threshold from which the monitoring time up to activation begins.</li> </ul>
	1-2-3-4	<b>Operation mode</b>	<ul style="list-style-type: none"> <li>Power-dependent: the function remains active until below the set power threshold.</li> <li>Time-dependent: The function is active depending on the sunlight for the set operating time.</li> </ul>
	1-2-3-4	<b>Operation time</b>	<p><b>NOTE:</b> The menu option is only available in the "Time-dependent" operation mode.</p> <ul style="list-style-type: none"> <li>After connection, the function is active for the set operating time.</li> </ul>
	1-2-3-4	<b>Quick start</b>	<ul style="list-style-type: none"> <li>Reduce the waiting times during the self-test by pressing the "Activate" key.</li> </ul>
	1-2-3-4	<b>Logging interval</b>	<ul style="list-style-type: none"> <li>Specify the time period between 2 log data recordings.</li> </ul>
	1-2-3-4	<b>Log data backup</b>	<p><b>NOTE:</b> The unit supports the backing up of all recorded yield data to a connected USB storage device.</p> <ul style="list-style-type: none"> <li>Activate or deactivate log data backup.</li> </ul>
	1-2-3-4	<b>Display</b>	<ul style="list-style-type: none"> <li>Configure the contrast setting for the display.</li> <li>Set the length of time without user input after which the backlighting switches off.</li> <li>Alternatively: Permanently activate or deactivate the backlighting by selecting "On" or "Off".</li> </ul>

Country-spec. setting	Menu level	Display/settings	Action in this menu/meaning
All countries	1-2-3-4	<b>Date &amp; time</b>	<ul style="list-style-type: none"> <li>☞ Set the date and time.</li> </ul> <p><b>NOTE:</b> For self-diagnostic purposes, the inverter carries out a daily restart at midnight. To avoid having a restart occur during feed-in operation and to always obtain reliable log data, ensure that the time is correctly set.</p>
	1-2-3-4	<b>Network</b>	<ul style="list-style-type: none"> <li>☞ Open the menu: Press the right arrow button or the Enter button.</li> </ul>
	1-2-3-4	<b>DHCP</b>	<ul style="list-style-type: none"> <li>☞ Activate or deactivate DHCP.</li> <li>☞ On: Activate DHCP. Once the DHCP server becomes available, the IP address, subnet mask, gateway and DNS server are automatically applied and the aforementioned menu items are hidden.</li> <li>☞ Off: DHCP deactivated, make settings manually.</li> </ul> <p><b>NOTE:</b> The "IP address", "Subnet masks", "Gateway" and "DNS server" menu options are only displayed with the DHCP deactivated.</p>
	1-2-3-4	<b>IP address</b>	<ul style="list-style-type: none"> <li>☞ Allocate a unique IPv4 address in the network.</li> </ul>
	1-2-3-4	<b>Subnet mask</b>	<ul style="list-style-type: none"> <li>☞ Assign a subnet mask.</li> </ul>
	1-2-3-4	<b>Gateway</b>	<ul style="list-style-type: none"> <li>☞ Enter IPv4 address of gateway.</li> </ul>
	1-2-3-4	<b>DNS server</b>	<ul style="list-style-type: none"> <li>☞ Enter IPv4 address of DNS server.</li> </ul>
	1-2-3-4	<b>Web server</b>	<ul style="list-style-type: none"> <li>☞ Open the menu: Press the right arrow button or the Enter button.</li> </ul>
	1-2-3-4	<b>Operation mode</b>	<ul style="list-style-type: none"> <li>☞ Activate or deactivate the integrated web server.</li> </ul>
	1-2-3-4	<b>Port</b>	<ul style="list-style-type: none"> <li>☞ Set the accessible port on the web server.</li> </ul>
	1-2-3-4	<b>Remote config</b>	<ul style="list-style-type: none"> <li>☞ If necessary, activate the remote configuration (on/off)</li> </ul>
	1-2-3-4	<b>Remote update</b>	<ul style="list-style-type: none"> <li>☞ If necessary, activate the remote update (on/off)</li> </ul>
	1-2-3-4	<b>Powador-web</b>	<ul style="list-style-type: none"> <li>☞ On: The inverter attempts to connect to the Powador-web web portal.</li> <li>☞ Off: The connection to Powador web is deactivated.</li> </ul>
	1-2-3-4	<b>Portal</b>	<ul style="list-style-type: none"> <li>☞ Set the portal configuration</li> </ul>
	1-2-3-4	<b>Modbus TCP</b>	<ul style="list-style-type: none"> <li>☞ Open the menu: Press the right arrow button or the Enter button</li> </ul>
	1-2-3-4	<b>Operation mode</b>	<ul style="list-style-type: none"> <li>☞ Activate/deactivate function.</li> </ul>
	1-2-3-4	<b>Port</b>	<ul style="list-style-type: none"> <li>☞ Set network port.</li> </ul>
	1-2-3-4	<b>Connection status</b>	<ul style="list-style-type: none"> <li>👁 Indicates the status of the network connection:</li> </ul>

Country-spec. setting	Menu level	Display/settings	Action in this menu/meaning
All countries	 "Parameters" menu		<ul style="list-style-type: none"> <li>☞ Press the right arrow button or the Enter button.</li> <li><b>NOTE:</b> The inverter does not display the "Parameters" menu in the standard configuration. To display the Parameters menu:                             <ol style="list-style-type: none"> <li>1. Open the menu.</li> <li>2. Simultaneously hold down the up and down buttons for several seconds.</li> </ol> </li> </ul>
	 Country		<ul style="list-style-type: none"> <li>☞ 1. Enter the four-digit password using the 4-way button. The password is unit-specific.</li> <li>☞ 2. Confirm the entry with the Enter button.</li> <li>☞ 3. Set the desired country setting.</li> <li><b>NOTE:</b> This option influences the country-specific operating settings of the inverter. Please consult KACO service for further information.</li> </ul>
DE, CH, ES, FR, GB, GR, IT, TH, ZA	 Grid type/guideline		<ul style="list-style-type: none"> <li>☞ Select the grid type for the inverter's installation location.</li> </ul>
UD	 Nominal grid voltage		<ul style="list-style-type: none"> <li>☞ Set the specified grid voltage for the site where the unit is used (please contact KACO Service)</li> </ul>
All countries	 Grid parameters		<ul style="list-style-type: none"> <li>☞ Open the menu: Press the right arrow button or the Enter button.</li> </ul>
DE-NS  , AT, BE  , BG, CY  , CH-NS  , CZ, FR (except FR-HTA), IE, IT, PL, UD	 Overvoltage shutdown, 10 minute mean value		<ul style="list-style-type: none"> <li>☞ Activate or deactivate password protection. </li> <li>☞ Specify the shutdown threshold for overvoltage shutdown. The 10-minute average for the measured voltage as per EN50160 is used.</li> <li>☞ Set period from occurrence of the fault to shutdown of the inverter.</li> </ul>
CZ, BG, FR (except FR-HTA), UD	 Voltage drop		<ul style="list-style-type: none"> <li>☞ The voltage drop between the inverter and the feed-in meter is added to the limit value that was set for grid shutdown according to EN 50160. The limit value can be set from 0 to 11 V in 1 V increments.</li> <li>☞ Specify the switch-off value for the voltage drop (0 to 11 V).</li> </ul>
DE-MS, AT, CH-MS, ES-661, ES1699, ES-PO123, FR-HTA, GB-G59/3, HR, HU, IE, IL, IN, IT, PL, RO, TH, ZA, UD	 Overvoltage shutdown		<ul style="list-style-type: none"> <li>☞ Specify the shutdown threshold for fast and slow overvoltage shutdown.</li> <li>☞ Set period from occurrence of the fault to shutdown of the inverter.</li> </ul>
	 Undervoltage shutdown		<ul style="list-style-type: none"> <li>☞ Specify the shutdown threshold for fast and slow undervoltage shutdown.</li> <li>☞ Set period from occurrence of the fault to shutdown of the inverter.</li> </ul>
AT, FR-HTA, GB-G59/3, IE, IT, PL, RO, TH, ZA, UD	 Overfrequency shutdown		<ul style="list-style-type: none"> <li>☞ Set limit value for the slow and fast overfrequency shutdown.</li> </ul>

Country-spec. setting	Menu level	Display/settings	Action in this menu/meaning
AT, FR-HTA, GB-G59-3, PL, RO, IE, IN, IT, TH, UD, ZA		<b>Underfrequency shutdown</b>	 <ul style="list-style-type: none"> <li>☞ Set limit value for the slow and fast underfrequency shutdown.</li> </ul>
AU, ES-1663, GR, PT, KR		<b>Voltage shutdowns</b>	<p>The inverter is equipped with redundant 3-phase monitoring. If the grid frequency exceeds or drops below the configured values, the inverter switches off. The minimum switch-off threshold can be set in 1 V increments.</p>  <ul style="list-style-type: none"> <li>☞ Configure the switch-off values for undervoltage and overvoltage.</li> <li>☞ Where necessary, set period from occurrence of the fault to shutdown of the inverter.</li> </ul>
DE-MS, AU, BG, CH-MS, CZ, DE-MS, ES, FR (except FR-HTA), GR, HU, IL, KR, PT		<b>Frequency shutdowns</b>	<p>The inverter continuously monitors the grid frequency. If the grid frequency exceeds or drops below the configured values, the inverter switches off.</p>  <ul style="list-style-type: none"> <li>☞ Set limit values for underfrequency and overfrequency in 0.1 Hz increments.</li> <li>☞ Set period from occurrence of the fault to shutdown of the inverter.</li> </ul>
AT, CH-MS, DE-MS, FR-HTA, IE, IL, IN, IT, PL, RO, TH, ZA, UD		<b>Connection cond.</b>	<p>The inverter checks mains voltage and frequency. The grid feed operation begins if the measured values are within the set ranges.</p>   <ul style="list-style-type: none"> <li>☞ Set minimum and maximum values for the switching on.</li> </ul>
AT, CH, DE, DK, BE, FR-HTA, GB, IL, IN, IT, IE, CY, Z, PL, RO, ES-PO123, TH, TW, ZA, UD		<b>Connect time</b>	  <ul style="list-style-type: none"> <li>☞ Set period for grid observation (in seconds) when switching on and reconnection after a fault.</li> </ul>
<b>Further information on: Grid parameters</b>			  <ul style="list-style-type: none"> <li>☞ If the value U&lt; (slow undervoltage shutdown) is set to a value which is greater than the value of Ucon,min (minimum restart voltage) using the LC display, then the value of Ucon, min. is automatically set to the value of U&lt;.</li> <li>☞ If the value U&gt; (slow overvoltage shutdown) is set to a value which is smaller than the value of Ucon,max (maximum restart voltage) using the LC display, then the value of Ucon, max. is automatically set to the value of U&gt;.</li> </ul>

Country-spec. setting	Menu level	Display/settings	Action in this menu/meaning
			<ul style="list-style-type: none"> <li>If the value <math>f &lt;</math> (slow underfrequency shutdown) is set to a value which is greater than the value of <math>f_{con,min}</math> (minimum restart frequency) using the LC display, then the value of <math>f_{con,min}</math> is automatically set to the value of <math>U &lt;</math>.</li> <li>If the value <math>f &gt;</math> (slow overfrequency shutdown) is set to a value which is smaller than the value of <math>f_{con,max}</math> (maximum restart frequency) using the LC display, then the value of <math>f_{con,max}</math> is automatically set to the value of <math>f &gt;</math>.</li> </ul>
All countries		<b>DC starting volt.</b>	<p>The inverter begins feed-in as soon as this DC voltage is present.</p> <ul style="list-style-type: none"> <li>Set the starting voltage.</li> </ul>
		<b>DC connection</b>	<ul style="list-style-type: none"> <li>Select between automatic detection and manual setting.</li> <li>Note the connection examples!</li> </ul>
		<b>Const. volt. ctrl.</b>	<p>Lets you deactivate the MPP seek mode in order to operate the inverter with a constant DC voltage.</p> <ul style="list-style-type: none"> <li>Activate or deactivate function.</li> <li>Set value for constant voltage control.</li> </ul>
All countries		<b>Power limitation</b>	<p>The output power of the inverter can be set permanently to a lower value than the maximum output power by the internal power limiting. This may be necessary in order to limit the maximum power rating of the system at the grid connection point, upon the grid operator's request.</p> <ul style="list-style-type: none"> <li>The value can be protected from the very first output limitation entry. After setting a limitation, the value can only be changed by entering a device-specific password.                             <ol style="list-style-type: none"> <li>Activate password protection if necessary.</li> <li>Specify the activation status.</li> <li>Specify the limit value for maximum feed-in power.</li> <li>Confirm the entry with the Enter button.</li> </ol> </li> </ul>
All countries		<b>Powador-protect</b>	<p>Configures the support for grid shutdown by a Powador protect connected to the digital input of the inverter.</p> <ul style="list-style-type: none"> <li>For Auto/On: A Powador protect is operating in the photovoltaic system and is connected to the inverter at the digital input/output.                             <ul style="list-style-type: none"> <li>Auto: The inverter automatically detects a Powador-protect integrated into the photovoltaic system.</li> <li>On: The digital signal of the Powador protect must be present to the digital input of the inverter for the inverter to start with feed-in.</li> <li>Off: The inverter does not check whether a Powador-protect is integrated into the PV system.</li> </ul> </li> </ul>

Country-spec. setting	Menu level	Display/settings	Action in this menu/meaning
All countries	1-2-3-4	<b>Iso.resistor</b>	 ⚙️ Set threshold value (in 1 kOhm steps) at which the insulation monitor reports a fault.
	1-2-3-4	<b>Power reduction P(f)</b>	 ⚙️ Open the menu: Press the right arrow button or the Enter button)
	1-2-3-4	<b>P(f) Operation mode</b>	⏪ ⚙️ Set operation mode (mode 1 / mode 2 / off) (not for IL, IT)
	1-2-3-4	<b>P (f) Activation threshold</b>	⚙️ Specify activation threshold (if mode 1 or mode 2 is active)
	1-2-3-4	<b>P (f) Deactivation threshold</b>	⚙️ Specify deactivation threshold (if „mode 1“ is active)
	1-2-3-4	<b>P(f) Deactivation time</b>	⚙️ Specify the time taken to shut down the power reduction function in mode 1 (not for IL, IT)
	1-2-3-4	<b>P(f) Gradient</b>	⚙️ Set gradient of power limit function with increasing frequency in % / Hz. This percentage relates to the nominal frequency of 50 Hz (If „mode 1“ or „mode 2“ active).
	1-2-3-4	<b>P(f) Deliberate delay</b>	⚙️ Set the power reduction delay in seconds (If „mode 1“ or „mode 2“ active).
DE-MS, AT, CH-MS, ES-PO123, FR-HTA, PL, IE, RO, TH, ZA-NERSA, UD	1-2-3-4	<b>Fault ride-through (FRT)</b>	 The inverter supports dynamic grid stabilisation (Fault Ride-Through). Open the menu: Press the right arrow button or the Enter button.
	1-2-3-4	<b>Operation mode</b>	⚙️ Specify the operation mode
	1-2-3-4	<b>Dead band</b>	⚙️ Set the dead band
	1-2-3-4	<b>Dead band mode</b>	⚙️ Specify the dead band mode
	1-2-3-4	<b>Constant k</b>	⚙️ Set constant k
	1-2-3-4	<b>Dynamic blind current</b>	⚙️ Activate dynamic blind current
All countries	1-2-3-4	<b>Reactive power</b>	⏪ ⚙️ Open the menu: Press the right arrow button or the Enter button. ⚙️ Activating idle power process: select process and press Enter. The active process is highlighted.
	1-2-3-4	<b>cos-phi specification</b>	⚙️ Configure power factor.  ⚙️ If a power factor not equal to 1 is selected: Select the type of phase shift (under-excited/over-excited).
All countries	1-2-3-4	<b>Q const.</b>	⚙️ Set the idle power Q (in %) to a fixed value.  ⚙️ Select the type of phase shift (under-excited/over-excited).
All countries	1-2-3-4	<b>cos-phi(P/Pn)</b>	⏪ ⚙️ Open the menu: Press the right arrow button or the Enter button.
	1-2-3-4	<b>Lock-in voltage</b>	 ⚙️ Set rated voltage, where the network support process is active.
	1-2-3-4	<b>Lock-out voltage</b>	



Country-spec. setting	Menu level	Display/settings	Action in this menu/meaning
All countries	1-2-3-4	<b>Number of support points</b>	<p>This option defines how many support points can be defined in the subsequent menu. The maximum number of configurable support points depends on the selected grid type.</p> <ul style="list-style-type: none"> <li>☞ Specify the number of support points for the idle power characteristic curve.</li> </ul>
	1-2-3-4	<b>1., ..., 10. Support point</b>	<ul style="list-style-type: none"> <li>☞ Specify the power factor for the 1., ..., 10. support point</li> <li>☞ If a power factor not equal to 0 is selected: Select the type of phase shift (under-excited/over-excited).</li> </ul>
	1-2-3-4	<b>Q(U) 10 support points</b>	<ul style="list-style-type: none"> <li>☞ Open the menu: Press the right arrow button or the Enter button.</li> </ul>
	1-2-3-4	<b>Lock-in power</b>	<ul style="list-style-type: none"> <li>☞ Power range set as % of rated power, in which the network support process is active.</li> </ul>
	1-2-3-4	<b>Lock-out power</b>	<ul style="list-style-type: none"> <li>☞ Power range set as % of rated power, in which the network support process is active.</li> </ul>
	1-2-3-4	<b>Transient time</b>	<ul style="list-style-type: none"> <li>☞ Set the response speed of the control.</li> </ul>
	1-2-3-4	<b>Dead time</b>	<ul style="list-style-type: none"> <li>☞ Set the deliberate delay for the start of the Q(U) function.</li> </ul>
	1-2-3-4	<b>Resetting the curve</b>	<ul style="list-style-type: none"> <li>☞ Resetting the active curve to reduce active power</li> </ul>
BE, CH-NS, CY, DE-NS, UD, TW	1-2-3-4	<b>Line error</b>	<p>Display of grid faults.</p> <ul style="list-style-type: none"> <li>☞ To show the last 5 grid fault messages, select the "Display" key.</li> </ul>
	1-2-3-4	<b>Protection parameters</b>	<p>Display of essential protection parameters.</p> <ul style="list-style-type: none"> <li>☞ To show the protection parameters, select the "Display" key.</li> </ul>
All countries	1-2-3-4	<b>"Information" menu</b>	<ul style="list-style-type: none"> <li>☞ Open the menu: Press the right arrow button or the Enter button.</li> </ul>
	1-2-3-4	<b>Inv. type</b>	<p>Displays the type designation of the inverter.</p> <ul style="list-style-type: none"> <li>☞ If feed-in power is actively limited: display maximum power in kW.</li> </ul>
	1-2-3-4	<b>SW version</b>	<ul style="list-style-type: none"> <li>☞ Displays the installed software version.</li> </ul>
	1-2-3-4	<b>Serial no.</b>	<ul style="list-style-type: none"> <li>☞ Displays the serial number of the inverter.</li> </ul>
	1-2-3-4	<b>Display country</b>	<p>Displays the selected country setting.</p> <ul style="list-style-type: none"> <li>☞ Optional: Displays the grid type if a grid type has been selected.</li> </ul>
	1-2-3-4	<b>"Manufacturer" menu</b>	<ul style="list-style-type: none"> <li>☞ The display shows information about the unit manufacturer.</li> </ul>

## 8.4 Monitor inverter

The inverter has an integrated web server. This makes it possible to monitor and record the operating state and yield of your PV system.

You can display the recorded data using:

- The integrated LCD
- The integrated web server using an Internet-capable device connected to the Ethernet interface of the inverter
- A storage medium connected to the USB interface, for example, a USB stick.

### 8.4.1 USB interface

Use an external USB storage device to read operating data saved in the inverter.

#### Reading log data



#### NOTE

The USB interface is approved solely for use with USB flash storage devices ("USB sticks"). The maximum available current is 100 mA. If a device with a higher power requirement is used, the power supply for the USB interface automatically shuts down to protect the inverter from damage.

#### Reading log data

1. Connect a suitable USB storage device to the USB interface on the underside of the inverter.
2. Open the "Log data display" menu.
3. Select the "Save to USB" item.
4. Select the desired log data using the 4-way button.
5. Press the Enter button.
- » The inverter saves the selected log data to the USB storage device.

### 8.4.2 Web server

The inverter has an integrated web server. After configuring the network and activating the web server in the Settings menu, you can open the web server from an Internet browser. The language version of the website delivered by the web server is adapted dynamically to the pre-set language preferences in your Internet browser. If your Internet browser requests a language that is unknown to the inverter, the web server uses the menu language set in the inverter.

#### Setting up the web server

##### Configuring the Ethernet interface

- ☺ You have connected the inverter to your network.
  - ☞ When using a DHCP server: Activate DHCP.
  - ☞ For manual configuration (DHCP off):
1. Open the Settings/Network menu.
  2. Assign a unique IP address.
  3. Assign a subnet mask.
  4. Assign a gateway.
  5. Assign DNS server.
  6. Save your settings.

#### Using the web server

To avoid problems with incompatibility, use the most recent version of your Internet browser. JavaScript must be enabled in the browser settings to display the web server correctly.

**NOTE**

You can also access the web server of the inverter via the Internet. To do this, additional settings of your network configuration, particularly your Internet router, are required. Note that communication with the inverter is carried out over an unsecured connection, particularly in the case of a connection over the Internet.

**Calling up the web server**

- ↻ Configure the Ethernet interface.
- ↻ Connect the Ethernet interface.
- 1. Open an Internet browser.
- 2. In the address field of the Internet browser, enter the IP address of the inverter and open the site.
- » The Internet browser displays the start screen of the web server.

After it has opened, the web server displays information about the inverter as well as the current yield data. The web server enables the following measurement data and yield data to be displayed:

- |                 |                     |
|-----------------|---------------------|
| • Feed-in power | • Generator power   |
| • Status        | • Generator voltage |
| • Grid power    | • Unit temperature  |
| • Grid voltage  |                     |

In order to display and export yield data, proceed as follows:

**Select the display period**

1. Open the web server.
2. Select the display period by choosing either daily view, monthly view, yearly view or overview.

**Filtering display data (daily view only)**

1. Open the web server.
2. Select daily view.
3. To show or hide measured values, select or deselect the corresponding checkboxes in the "Select display" area.

**Exporting data**

1. Filter the display data if necessary.
2. Select the display period if applicable (daily, monthly, yearly or overview).
3. Press the "Export data" button.
4. Save the file.

**NOTE**

Regardless of the display data selected in the "Select display" area, an export file always contains all measurement data and yield data available for the selected period.

## 8.5 Performing a software update

You can update the software of the inverter to a new version using the integrated USB interface. Use a FAT32-formatted USB stick to do this. Do not use any storage media with an external power supply (for example: an external hard disk).



### NOTE

Ensure that the AC and DC inverter power supply is active. It is only possible to update all of the inverter's components to the most current software version in this operating state.

### CAUTION

#### Damage to the inverter

The update can fail if the power supply is interrupted during the update process. Parts of the software or of the inverter itself can then be damaged.

- » Never disconnect the DC and AC power supply during a software update.
- » Do not remove the USB stick during a software update.

#### Preparing for the software update

1. Download the software update file from the KACO web site and store it on your hard disk.
2. Copy the update file (.KUF) onto the USB stick.
- » Perform software update.



### NOTE

The update can take several minutes. The "Operating" LED flashes during the update process. The inverter may restart several times.

The following message appears if the DC power supply is too low: "DC power supply too low! Perform update anyway?".

In this case, select "No" and perform the update with a stable voltage supply.

#### Performing the software update

- ⌚ Prepare for the software update.
- 1. Connect the USB stick to the inverter.
  - » The message "Software found. Would you like to load it?" appears on the display.
- 2. If you would like to perform the update, select the "Yes" button. In the case of "No", pressing the "Enter" button stops the update process and the unit goes into feed-in mode.
  - » The inverter begins the update.
    - The update has been imported in full once the message "Software update successful" appears.
    - The update has failed if the message "Software update incomplete" appears.
- 3. When a fault occurs, the update process must be repeated.

Alternatively, you can check to see if the update was successful in the menu:

#### Displaying the software version

- ☞ Open the Information / Software Version menu.
- » The inverter will display the versions and checksums of the software that is currently loaded.

## 9 Maintenance/Troubleshooting

### 9.1 Visual inspection

Inspect the inverter and the cables for exterior visible damage and note the operating status display of the inverter. In case of damage, notify your installer. Repairs may only be carried out by authorised electricians.



#### NOTE

The inverter should be checked for proper operation by a qualified electrician at regular intervals.

### 9.2 Cleaning the inverter externally



#### DANGER



#### Lethal voltages in the inverter.

Serious injuries or death can result if moisture enters the system.

- › Only use completely dry objects to clean the inverter.
- › Only the exterior of the inverter should be cleaned.

#### Cleaning the inverter

- ☞ Do not use compressed air.
- ☞ Use a vacuum cleaner or a soft brush to remove dust from the fan cover, between the cooling fins and from the top side of the inverter on a regular basis.
- ☞ Remove dust from the ventilation inlets if necessary.
- ☞ If necessary, remove the fan cover and remove deposits.

### 9.3 Replacing or cleaning the fan

The inverter is equipped with 1 axial fan. It is located in the upper right area of the housing.

Replace the fan:

- In case of heavy soiling
- If it is defective

#### Removing the fan

1. Ensure complete disconnection on the AC and DC sides.
  2. Wait until the fan is no longer turning.
  3. Unscrew the Torx screws of the side housing cover (Figure 29 on page 45).
  4. Remove the side housing cover.
  5. Unplug the fan plug.
  6. Remove the side housing cover with the fan from the housing.
  7. Remove the fan from the side housing cover by pulling it away from the cover or disassemble fan from the side housing cover by the tree assembly screws. (See position 1 & 2 in Figure 31)
- » Install the replacement fan.

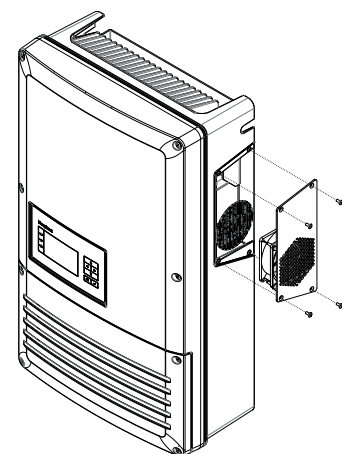

Figure 29: Removing the side housing cover

### Installing the replacement fan

- ⊖ You have removed the defective fan.
  - ⊖ Replace the fan only with a fan recommended by KACO new energy. If necessary, contact KACO service.
1. Place the new fan in the holding fixture (Figure 30 or Figure 31 on page 46).
  2. Plug in the fan plug  
or  
assemble fan with assembly screws. (See position 1 & 2 in Figure 31)
  3. Place the side housing cover on the unit.
  4. Fasten the side housing cover to the unit with the Torx screws.
  5. Check that the fittings are secure and that the terminals are well seated.
- » The replacement fan is ready for operation.

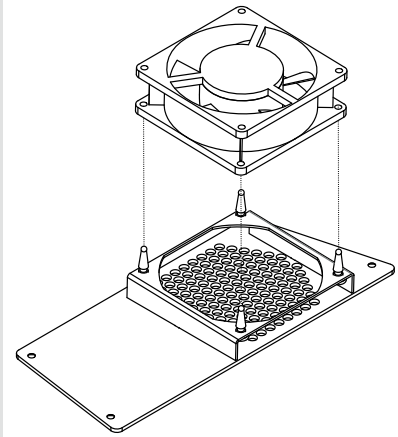

Figure 30: Replacing the fan

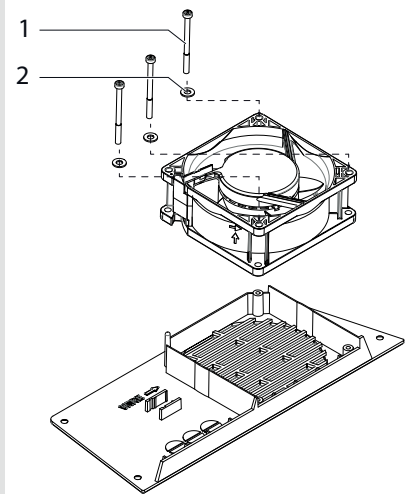

Figure 31: Replacing the fan

## 9.4 Shutting down for maintenance and troubleshooting

### DANGER

**Lethal voltages are still present in the terminals and cables of the inverter even after the inverter has been switched off and disconnected.**

Severe injuries or death will occur when touching the cables and terminals in the inverter.

When there is solar radiation, DC voltage will be present at the open ends of the DC cables. Arcing may occur if the DC cables are disconnected while they are still live.

Only appropriately qualified and authorised electricians may open and maintain the inverter.



- › Observe all safety regulations and the current technical connection specifications from the relevant power supply company.
- › Disconnect the AC and DC sides.
- › Secure the AC and DC sides from being inadvertently switched back on.
- › Do not touch the exposed ends of the cables.
- › Avoid short circuits.
- › Do not open the inverter until these two steps are complete.
- › After shutdown, wait at least five minutes before working on the inverter.

 **Authorised electrician**

### CAUTION

#### Destruction of the DC connections or fuse holders

The connection terminals or fuse holders can be destroyed by arcing if disconnected or if the fuses are removed.

- › It is absolutely essential that the shutdown sequence is carried out in the correct order.

#### Shutting down the inverter

1. Switch off the grid voltage by turning off the external circuit breakers.
2. Disconnect the PV generator using the DC isolator switch.

#### DANGER! The DC cables are still live.

- ☞ Ensure that there is no voltage present on the grid connection terminals.

## 9.5 Disconnecting connections

### 9.5.1 Disconnecting the AC connection

#### DANGER

#### Danger to life from electric shock!



Never disconnect the connection plug and plug connector under load.

- › Switch off the grid voltage by turning off the external circuit breakers before you detach the AC cables from the screw terminal.
- › Make sure that the device is isolated from the public power supply and the system power supply before starting work.

#### Disconnecting the AC connection

- ☞ Ensure there is no AC/DC voltage present.
1. Open the connection area.
  2. Switch off the grid voltage by turning off the external circuit breakers.
  3. Detach cables (L1/L2/L3/N/PEN) from the AC connection terminal.
  4. Detach the PE line from the earthing bolt.
  5. Loosen the cable fitting and pull the cables out through the cable fitting.

### 9.5.2 Disconnecting the DC connection

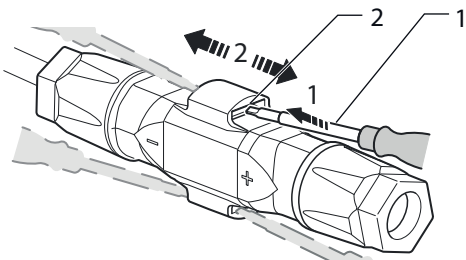

Figure 32: Disconnect connector

#### Key

1	Screwdriver	2	Latch
---	-------------	---	-------

**Disconnect DC plug connection**

- ⌚ Ensure there is no AC/DC voltage present.
- 1. Disconnect the PV generator using the DC isolator switch.
- 2. Use a screwdriver (blade width 3 mm) to push down the latch on the coupling.
- 3. Leave the screwdriver in place.
- 4. Disconnect the DC connector from the DC socket.

**DANGER! The DC cables are still live.**

- ☞ Ensure that there is no voltage present on the grid connection terminals.

## 9.6 Faults

### 9.6.1 Procedure



**DANGER**

**Lethal voltages are still present in the terminals and cables of the inverter even after the inverter has been switched off and disconnected.**

Severe injuries or death will occur when touching the cables and terminals in the inverter.

- ☞ When a fault occurs, notify an appropriately authorised and qualified electrician or KACO new energy GmbH Service.
- ☞ The operator can only carry out actions marked with a B.

- ☞ In case of power failure, wait for the system to automatically restart.

- ☞ Notify your electrician if there is an extended power failure.

**B = Action of the operator**

**E = The indicated work may only be carried out by an authorised electrician.**

**K = The indicated work may only be carried out by a service employee of KACO new energy GmbH!**

### 9.6.2 Rectifying a fault

Fault	Cause of fault	Explanation/remedy	By
The display is blank and the LEDs do not light up.	Grid voltage not available	☞ Check whether the DC and AC voltages are within the permitted limits (see Technical Data).	<b>E</b>
		☞ Notify KACO Service.	<b>E</b>
The inverter stops feeding into the grid shortly after being switched on, even though there is sunlight present.	Faulty grid separation relay in the inverter.	If the grid separation relay is defective, the inverter will recognise this during the self-test.	
		☞ Ensure that there is sufficient PV generator power.	<b>E</b>
		☞ If the grid separation relay is defective, have it replaced by KACO Service.	<b>K</b>
☞ Notify KACO Service.			
The inverter is active but is not feeding into the grid. The display indicates a line failure.	Grid-feed is interrupted due to a grid fault.	Due to a grid fault (grid impedance too high, over/undervoltage, over/underfrequency), the inverter stopped the feed-in process and disconnected from the grid for safety reasons.	
		☞ Change the line parameters within the permitted operating limits (see the "Start-Up" section).	<b>E</b>







Fault	Cause of fault	Explanation/remedy	By
The grid fuse trips.	The grid fuse capacity is too low.	In case of a high level of solar radiation, the inverter exceeds its rated current for a short period, depending on the PV generator.	
		☞ Select the capacity of the inverter's pre-fuse to be somewhat higher than the maximum feed-in current (see the "Installation" section).	<b>E</b>
		☞ Contact the grid operator if the grid failure continues to occur.	<b>E</b>
The grid fuse trips.	Damage to the inverter's hardware.	If the grid fuse trips immediately when the inverter goes into feed-in mode (after the start-up period is complete), the inverter's hardware is probably damaged.	
		☞ Contact KACO Service to test the hardware.	<b>E</b>
The inverter displays an impossible daily peak value.	Faults in the grid.	The inverter continues to operate as normal without losses to the yield, even when an erroneous daily peak value is displayed. The value is reset overnight.	
		☞ To reset the value immediately, switch the inverter off by disconnecting it from the grid and switching off the DC, then switch it back on.	<b>E</b>
Daily yields do not correspond to the yields on the feed-in meter.	Tolerances of the measuring elements in the inverter.	The measuring elements of the inverter have been selected to ensure maximum yields. Due to these tolerances, the daily yields shown may deviate from the values on the feed-in meter by up to 15%.	
		☞ No action	-
The inverter is active but is not feeding into the grid. Display: "Waiting for feed-in"	<ul style="list-style-type: none"> <li>• Generator voltage too low</li> <li>• Grid voltage or PV generator voltage unstable.</li> </ul>	<ul style="list-style-type: none"> <li>• The PV generator voltage or power is not sufficient for feed-in (solar radiation is too low).</li> <li>• The inverter checks the grid parameters before the feed-in process begins. The length of time it takes to switch back on again differs from country to country, depending on applicable standards and regulations, and may be several minutes.</li> <li>• The starting voltage may have been set incorrectly.</li> </ul>	
		☞ Adjust starting voltage in the Parameter menu if required.	<b>E</b>

Fault	Cause of fault	Explanation/remedy	By
Noise emission from the inverter.	Particular ambient conditions.	<p>When there are certain ambient conditions, the units may emit audible noises.</p> <ul style="list-style-type: none"> <li>• Grid interference or grid failure caused by particular loads (motors, machines, etc.) which are either connected to the same point on the grid or located in the vicinity of the inverter.</li> <li>• In cases of volatile weather conditions (frequent switching between sunny and cloudy conditions) or strong solar radiation, a light hum may be audible due to the increased power.</li> <li>• Under particular grid conditions, resonances may form between the unit's input filter and the grid; these may be audible even when the inverter is switched off.</li> </ul> <p>These noise emissions do not affect the operation of the inverter. They do not lead to loss of performance, failure, damage or to a shortening of the unit's service life.</p> <p>People with very sensitive hearing (particularly children) are able to hear the high-frequency hum caused by the inverter's operating frequency of approximately 17 kHz.</p> <p>☞ No action</p>	
In spite of high radiation levels, the inverter does not feed the maximum power into the grid.	The device is too hot and the system limits the power.	<p>Because the temperatures inside the unit are too high, the inverter reduces its power to prevent damage to the unit. Note the technical data. Ensure that the convection cooling is not impeded from the exterior. Do not cover the cooling fins.</p> <p>☞ Ensure sufficient cooling of the unit.</p> <p>☞ Do not cover the cooling fins.</p>	<b>B, E</b>

## 9.7 "Fault" messages on the display/LED

Many fault signals indicate a fault in the grid. They are not operational faults of the inverter. The triggering levels are defined in standards, e.g. VDE0126-1-1. The inverter shuts down if the values exceed or fall below the approved levels.

### 9.7.1 Display of status and fault messages

Display	Fault LED (red)		
<b>FS (fault status)</b>	 	<b>ON</b>	<ul style="list-style-type: none"> <li>• Fault signal relay has switched.</li> <li>• Feed-in was ended due to a fault.</li> </ul>
<b>OS (operating status)</b>	 	<b>OFF</b>	<ul style="list-style-type: none"> <li>• The fault signal relay releases again.</li> <li>• The inverter feeds back into the grid again after a country-specific time period.</li> </ul>

Details regarding the fault or operating status can be found either on the display or in the data that was recorded through the RS485 interface.

### Status and fault signals

The following table lists the possible status and fault signals that the inverter shows on the LCD and the LEDs.

**BS = operating status, FS = fault status;**

**B = Action of the operator**

**E = The indicated work may only be carried out by an authorised electrician.**

**K = The indicated work may only be carried out by a service employee of KACO new energy GmbH!**







































Status	Display			Explanation	Action		
OS	1	Waiting for feed-in			Self-test: The grid parameters and generator voltage are being checked.	-	-
OS	2	Generator voltage too low			Insufficient generator voltage and power, status before the transition to night shutdown	-	-
OS	8	Self-test			Checks the shutdown of the power electronics as well as the grid relay before feed-in mode.	-	-
FS	10	Temperature in unit too high			In case of overheating, the inverter switches off. Possible causes: <ul style="list-style-type: none"> <li>Excessively high ambient temperature,</li> <li>Fan covered,</li> <li>Inverter defective.</li> </ul>	 Cool off the area around the inverter. <b>B</b>  Uncover the fans. <b>B</b>  Notify your authorised electrician. <b>E</b>	
OS	11	Measured values			Power limitation: If the generator power is too high, the inverter limits itself to the maximum power (e.g. around noon if the generator capacity is too large).	-	-
FS	17	Shutting down Powador-protect			The activated grid and system protection has been tripped.	 Wait for reactivation. <b>E</b>  Notify your authorised electrician if the fault occurs several times.	
FS	18	Resid. current shutdown			Residual current was detected. The feed-in was interrupted.	 Notify your authorised electrician. <b>E</b>	
FS	19	Insulation fault generator			There is an insulation fault on the PV generator. The feed-in was interrupted.	 Notify your authorised electrician if the fault occurs several times. <b>E</b>	
FS	30	Fault Transformer fault			The current and voltage measurements in the inverter are not within acceptable range.	-	-
FS	32	Fault Self-test			The internal grid separation relay test has failed.	 Notify your authorised electrician if the fault occurs several times. <b>E</b>	
FS	33	Fault DC feed-in			The DC feed-in has exceeded the permitted value. This DC feed-in can be caused by grid conditions and may not necessarily indicate a fault.	 Notify your authorised electrician if the fault occurs several times. <b>E</b>	
FS	34	Internal communication error			A communication error has occurred in the internal data transmission.	 Notify your authorised electrician. <b>E</b>  Check the data cable.	
FS	35	Protection shutdown SW			Protective shutdown of the software (AC overvoltage, AC overcurrent, DC link overvoltage, DC overvoltage, DC overtemperature).	Not a fault Grid-related shutdown, the grid connects again automatically.	

Table 7: Operating status and fault messages on the display









































Status	Display			Explanation	Action	
FS 36	Protection shut-down HW			Protective shutdown of the hardware (AC overvoltage, AC overcurrent, DC link overvoltage).	Not a fault Grid-related shutdown, the grid connects again automatically.	
FS 38	Generator overvoltage error			The voltage of the DC generator is too high. The PV generator is configured incorrectly.	 Notify your authorised electrician.	<b>E</b>
FS 41, 42, 43, 44, 45, 46	Line failure: Under voltage L1, Over voltage L1, Under voltage L2, Over voltage L2, Under voltage L3, Over voltage L3,			The voltage of a grid phase is too low; the grid cannot be fed into. The phase experiencing failure is displayed.	 Notify your authorised electrician.	<b>E</b>
FS 47	Grid failure phase-to-phase voltage			The measured line-to-line voltage is outside of the tolerance limits.		
FS 48	Line failure Underfrequency			Grid frequency is too low. This fault may be grid-related.	 Notify your authorised electrician.	<b>E</b>
FS 49	Line failure Overfrequency			Grid frequency is too high. This fault may be grid-related.	 Notify your authorised electrician.	<b>E</b>
FS 50	Line failure average voltage			The grid voltage measurement according to EN 50160 has exceeded the maximum permitted limit value. This fault may be grid-related.	 Notify your authorised electrician.	<b>E</b>
FS 57	Waiting for reactivation			Waiting time of the inverter after a fault.	Inverter does not switch on again until the country-specific time has elapsed.	
FS 58	Overtemperature Control card			The temperature inside the unit was too high. The inverter switches off to prevent damage to the hardware.	 Provide for sufficient ventilation.	<b>E</b>
FS 59	Self test error			A fault occurred during a self-test.	 Disconnect the DC/AC Power and wait 5 minutes for restart  Notify your authorised electrician.	<b>B</b> <b>E</b>
OS 60	Generator voltage too high			The inverter does not begin feeding into the grid until the PV voltage falls below a specified value.	-	-
OS 61	External limit (%)			The external limit <i>Power control</i> was activated by the grid operator. The inverter limits its power.		
OS 63	Measured values			P(f)/frequency-dependent power reduction: Frequency-dependent power reduction will be activated when the BDEW (German Association of Energy and Water Industries) Medium Voltage Directive goes into effect. Power reduction starts at a frequency of 50.2 Hz.		
OS 64	Measured values			Output current limiting: The AC current is limited once the specified maximum value has been reached.		
FS 67	Fault at power section 1			There is a fault in the power section.	 Notify your authorised electrician.	<b>E</b>

Table 7: Operating status and fault messages on the display











































Status	Display			Explanation	Action	
FS 70	Fan error			The fan is malfunctioning.	 Replace defective fan.	<b>E</b>
FS 73	Standalone grid err.			Standalone mode was detected.	-	-
OS 74	External idle power requirement			The grid operator limits the feed-in power of the inverter.	-	-
OS 79	Insulation measurement			PV generator's insulation is being measured	-	-
FS 80	Insulation meas. not possible			The insulation measurement cannot be performed because the generator voltage is too volatile.	-	-
FS 81, 82, 83	Protection shutdown line volt. L1, L2, L3			Overvoltage has been detected on a conductor. An internal protective mechanism has disconnected the device to protect it against damage.	 In case of repeated occurrence: Notify your authorised electrician.	<b>E</b>
FS 84	Protection shutdown undervolt. DC link			A voltage deviation has been found in the DC link. An internal protective mechanism has disconnected the device to protect it against damage.	 In case of repeated occurrence: Notify your authorised electrician.	<b>E</b>
FS 85	Protect. shutdown overvolt. DC link			Overvoltage has been found in the DC link. An internal protective mechanism has disconnected the device to protect it against damage.	 In case of repeated occurrence: Notify your authorised electrician.	<b>E</b>
FS 86	Protect. shutdown DC link asymmetry			Overvoltage has been found in the DC link. An internal protective mechanism has disconnected the device to protect it against damage.	 In case of repeated occurrence: Notify your authorised electrician.	<b>E</b>
FS 87, 88, 89	Protection shutdown overcurrent L1, L2, L3			A current that has been found on a conductor is too high. An internal protective mechanism has disconnected the device to protect it against damage.	 In case of repeated occurrence: Notify your authorised electrician.	<b>E</b>
FS 93, 94	Self test error Buffer 1, Buffer 2			The control board is defective.	 Notify authorised electrician / KACO Service	<b>E/K</b>
FS 95, 96	Self test error Relay 1, Relay 2			The power section is defective.	 Notify KACO Service	<b>K</b>
FS 97	Protection shutdown overcurrent HW			Too much power has been fed into the grid. Complete disconnection of the device.	 Notify authorised electrician / KACO Service	<b>E/K</b>
FS 98	Protect. shutdown HW gate driver			An internal protective mechanism has disconnected the device to protect it against damage. Complete disconnection of the device.	 Notify authorised electrician / KACO Service	<b>E/K</b>
FS 99	Protect. shutdown: HW buffer free			An internal protective mechanism has disconnected the device to protect it against damage. Complete disconnection of the device.	 Notify authorised electrician / KACO Service	<b>E/K</b>

Table 7: Operating status and fault messages on the display









Status	Display	 	Explanation	Action	
FS 100	Protect. shutdown HW overheating	 	The device has been switched off because the temperatures in the housing were too high.	 Check to make sure that the fans are working.  Replace fan if necessary.	<b>B</b> <b>E</b>
FS 101 to 106	Temperature plausibility error, efficiency, DC link, AFI module, relay, DC/DC converter	 	The unit has shut down because of implausible internal measured values.	 Notify KACO Service	<b>K</b>

Table 7: Operating status and fault messages on the display

## 10 Service

If you need help solving a technical problem with one of our KACO products, please contact our service hotline.

Please have the following information ready so that we can help you quickly and efficiently:

- Device name / serial number
  - Date of installation / Start-up report
  - Fault message shown on the display / Description of the fault / Did you notice anything unusual? / What has already been done to analyse the fault?
  - Module type and string circuit
  - Consignment identification / Delivery address / Contact person (with telephone number)
  - Information about the accessibility of the installation site.
- Any additional costs arising from unfavourable structural or mounting conditions shall be billed to the customer.

You can find the following items and other information at our web site <http://www.kaco-newenergy.de/>:

- our current warranty conditions,
  - a complaint form,
  - a form for registering your device with us. Please register your unit without delay. In this manner, you can assist us in providing you with the quickest service possible.
- Note: The maximum length of the warranty is based on the currently applicable national warranty conditions.

### Hotlines

	Technical troubleshooting	Technical consultation
Inverters	+49 (0) 7132/3818-660	+49 (0) 7132/3818-660
Data logging and accessories	+49 (0) 7132/3818-690	+49 (0) 7132/3818-690
Customer Service	Monday to Friday from 8:00 a.m. to 5:00 p.m. (CET)	

## 11 Shutdown/Disassembly

### 11.1 Shutting down the inverter

#### **DANGER**

**Lethal voltages are still present in the terminals and cables of the inverter even after the inverter has been switched off and disconnected.**



Severe injuries or death will occur when touching the cables and terminals in the inverter.

When there is solar radiation, DC voltage will be present at the open ends of the DC cables. Arcing may occur if the DC cables are disconnected while they are still live.

- › It is absolutely essential that the shutdown sequence be carried out in the correct order.
- › After shutdown, wait at least 30 minutes before working on the inverter.
- › When working on photovoltaic modules, in addition to disconnecting from the grid, always disconnect the DC main switch on the generator junction box at all poles (or the DC plug connectors). Simply disconnecting the grid voltage is not sufficient!

#### **CAUTION**



**Risk of burns from hot housing components.**

The housing surface and the heat sink can adopt a surface temperature of 75° in operation.

- › Do not touch the housing surface or heat sink during and immediately after operation.
- › Allow the device to cool down before touching the housing surface.

#### **DANGER**



**Destruction of the DC plug connectors**

DC plug connectors can be destroyed by arcing if disconnected while still live. It is absolutely essential that the following shutdown sequence be carried out in the correct order:

1. Switch off the grid voltage by turning off the external circuit breakers.
2. Switch off the PV generator using the DC isolator switch.

**DANGER!** The DC cables are still live!

3. Ensure that there is no voltage present on the grid connection terminals.

### 11.2 Uninstalling the device

- Inverter disconnected and secured against restart.
- 1. Open the connection area.
- 2. Remove the interface cable.
- 3. Detach DC connection plug.
- 4. Detach AC connection cables for the connection terminals.
- 5. Open the cable fittings.
- 6. Pull out the cables.
- » The inverter is uninstalled. Proceed with disassembly.

### 11.3 Disassembling the unit

1. Unit has been switched off and uninstalled.
2. Unscrew the detachment protector.
3. Take the unit down from the mounting plate.
4. Securely pack up the unit if it is to be used later, or have the unit disposed of in the correct manner.

## 11.4 Packaging the unit

⌚ The inverter is uninstalled.

1. If possible, always pack the inverter in the original packaging. If this is no longer available, an alternative is to use equivalent packaging.
2. You must be able to close the box completely and it must be able to accommodate the weight and size of the inverter.

## 11.5 Storing the unit

⌚ The inverter is packed.

- ☞ Store the inverter in a dry place, in accordance with the ambient temperature range (see chapter 4.2 on page 11).

## 12 Disposal

### CAUTION



#### **Risk to the environment if disposal is not carried out in the correct manner**

For the most part, both the inverter and the corresponding transport packaging are made from recyclable raw materials.

**Unit:** Do not dispose of faulty inverters or accessories together with household waste. Ensure that the old unit and any accessories are disposed of in a proper manner.

**Packaging:** Ensure that the transport packaging is disposed of properly.



## 13 EU Declaration of Conformity

<b>Manufacturer's name and address</b>	<b>KACO new energy GmbH</b> Carl-Zeiss-Strasse 1 74172 Neckarsulm, Germany
<b>Product description</b>	<b>Photovoltaic feed-in inverter</b>
<b>Type designation</b>	<b>Powador 12.0 TL3 - INT / Powador 14.0 TL3 - INT / Powador 18.0 TL3 - INT / Powador 20.0 TL3 - INT</b>

This is to confirm that the units listed above comply with the protection requirements set forth in the Directive of the Council of the European Union of 26 February 2014 on the harmonisation of the laws of the member states relating to Electromagnetic Compatibility (2014/30/EU) and the Low Voltage Directive (2014/35/EU).

The units conform to the following standards:

### 2014/35/EU

"Directive relating to electrical equipment designed for use within certain voltage limits"

### 2014/30/EU

"Directive relating to electromagnetic compatibility"

### Safety of the unit

IEC 62109-1:2010  
IEC 62109-2:2011

### Interference immunity

EN 61000-6-1:2007  
EN 61000-6-2:2005

### Emitted interference

EN 61000-6-3:2007 + A1:2011  
EN 61000-6-4:2007 + A1:2011

### Secondary effects on the grid

EN 61000-3-2:2006\* + A1:2009 + A2:2009  
EN 61000-3-3:2008\*  
EN 61000-3-11:2000\*\*  
EN 61000-3-12:2011\*\*

\* valid for device types with a nominal current  $\leq 16$  A

\*\* valid for device types with a nominal current  $\geq 16$  A

The types mentioned above are therefore labelled with the CE mark.

Unauthorised modifications to the supplied units and/or any use of the units that is contrary to their intended use render this Declaration of Conformity null and void.

Neckarsulm, 20.04.2016  
KACO new energy GmbH



p.p. Matthias Haag  
Member of the Executive Board for Technology / CTO





