

User Manual

3.5KW-5.5KW INVERTER / CHARGER

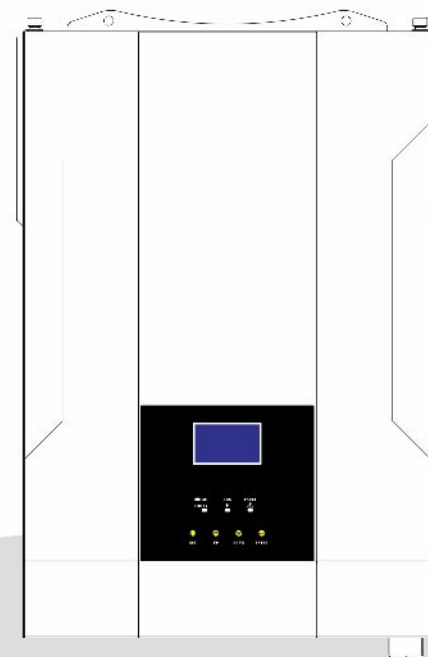

Table Of Contents

ABOUT THIS MANUAL	1
Purpose	1
Scope	1
SAFETY INSTRUCTIONS	1
INTRODUCTION	2
Features	2
Basic System Architecture	2
Product Overview	3
INSTALLATION	4
Unpacking and Inspection	4
Preparation	4
Mounting the Unit	4
Battery Connection	5
AC Input/Output Connection	7
PV Connection	9
Final Assembly	11
Communication Connection	11
OPERATION	12
Power ON/OFF	12
Operation and Display Panel	12
LCD Display Icons	13
LCD Setting	15
Display Setting	22
Operating Mode Description	26
Battery Equalization Description	28
CLEARANCE AND MAINTENANCE FOR ANTI-DUST KIT	30
Fault Reference Code	31
Warning Indicator	31
SPECIFICATIONS	32
Table 1 Line Mode Specifications	32
Table 2 Inverter Mode Specifications	33
Table 3 Charge Mode Specifications	34
Table 4 General Specifications	34
TROUBLE SHOOTING	35
Appendix: Approximate Back-up Time Table	37

ABOUT THIS MANUAL

Purpose

This manual describes the assembly, installation, operation and troubleshooting of this unit. Please read this manual carefully before installations and operations. Keep this manual for future reference.

Scope

This manual provides safety and installation guidelines as well as information on tools and wiring.

SAFETY INSTRUCTIONS



WARNING: This chapter contains important safety and operating instructions. Read and keep this manual for future reference.

1. Before using the unit, read all instructions and cautionary markings on the unit, the batteries and all appropriate sections of this manual.
2. CAUTION -- To reduce risk of injury, charge only deep-cycle lead acid type rechargeable batteries.
Other types of batteries may burst, causing personal injury and damage.
3. Do not disassemble the unit. Take it to a qualified service center when service or repair is required. Incorrect re-assembly may result in a risk of electric shock or fire.
4. To reduce risk of electric shock, disconnect all wirings before attempting any maintenance or cleaning. Turning off the unit will not reduce this risk.
5. CAUTION – Only qualified personnel can install this device with battery.
6. NEVER charge a frozen battery.
7. For optimum operation of this inverter/charger, please follow required spec to select appropriate cable size. It's very important to correctly operate this inverter/charger.
8. Be very cautious when working with metal tools on or around batteries. A potential risk exists to drop a tool to spark or short circuit batteries or other electrical parts and could cause an explosion.
9. Please strictly follow installation procedure when you want to disconnect AC or DC terminals. Please refer to INSTALLATION section of this manual for the details.
10. One piece of 150A fuse is provided as over-current protection for the battery supply.
11. GROUNDING INSTRUCTIONS - This inverter/charger should be connected to a permanent grounded wiring system. Be sure to comply with local requirements and regulation to install this inverter.
12. NEVER cause AC output and DC input short circuited. Do NOT connect to the mains when DC input short circuits.
13. Warning!! Only qualified service persons are able to service this device. If errors still persist after following troubleshooting table, please send this inverter/charger back to local dealer or service center for maintenance.

INTRODUCTION

This is a multi-function inverter/charger, combining functions of inverter, solar charger and battery charger to offer uninterrupted power support with portable size. Its comprehensive LCD display offers user-configurable and easy-accessible button operation such as battery charging current, AC/solar charger priority, and acceptable input voltage based on different applications.

There are two different types of built-in solar chargers: PWM and MPPT solar charger. For the detailed product specification, please consult your local dealers.

Features

- Pure sine wave inverter
- Configurable input voltage range for home appliances and personal computers via LCD setting
- Configurable battery charging current based on applications via LCD setting
- Configurable AC/Solar Charger priority via LCD setting
- Compatible to mains voltage or generator power
- Auto restart while AC is recovering
- Overload/ Over temperature/ short circuit protection
- Smart battery charger design for optimized battery performance
- Cold start function

Basic System Architecture

The following illustration shows basic application for this inverter/charger. It also includes following devices to have a complete running system:

- Generator or Utility.
- PV modules

Consult with your system integrator for other possible system architectures depending on your requirements.

This inverter can power all kinds of appliances in home or office environment, including motor-type appliances such as tube light, fan, refrigerator and air conditioner.

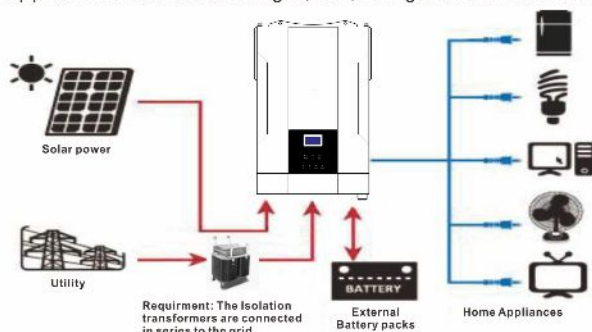
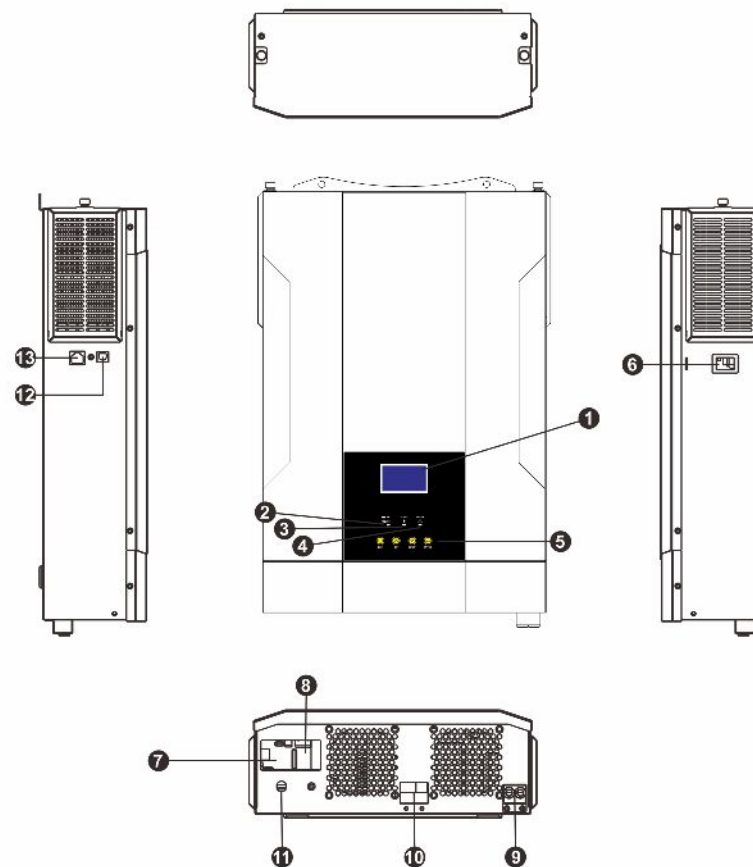

Figure 1 Hybrid Power System

One detection device needs be connected between the PV + and PV- & the ground, to ensure leakage current between PV + and PV- & the ground is less than 30mA.

Isolation transformer Specs. : 10KW—220:220V 60*100 single phase Isolation transformer.

Product Overview



- 1.LCD display
- 2.Status indicator
- 3.Charging indicator
- 4.Fault indicator
- 5.Function buttons
- 6.Power on/off switch
- 7.AC input
- 8.AC output
- 9.PV input
- 10.Battery input
- 11.Circuit breaker
- 12.USB communication port
- 13.RS-232 communication port

INSTALLATION

Unpacking and Inspection

Before installation, please inspect the unit. Be sure that nothing inside the package is damaged. You should have received the following items inside of package:

- The unit x 1
- User manual x 1
- Communication cable x 1

Preparation

Before connecting all wirings, please take off bottom cover by removing two screws as shown below.

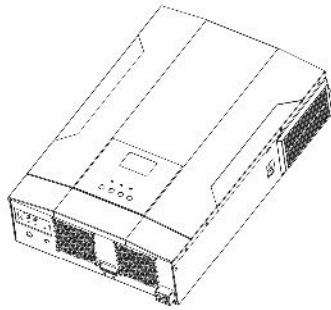

Mounting the Unit

Consider the following points before selecting where to install:

- Do not mount the inverter on flammable construction materials.
- Mount on a solid surface
- Install this inverter at eye level in order to allow the LCD display to be read at all times.
- For proper air circulation to dissipate heat, allow a clearance of approx. 20 cm to the side and approx. 50 cm above and below the unit.
- The ambient temperature should be between 0°C and 55°C to ensure optimal operation.
- The recommended installation position is to be adhered to the wall vertically.
- Be sure to keep other objects and surfaces as shown in the diagram to guarantee sufficient heat dissipation and to have enough space for removing wires.

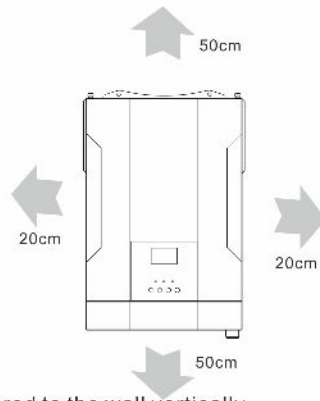

SUITABLE FOR MOUNTING ON CONCRETE OR OTHER NON-COMBUSTIBLE SURFACE ONLY.

Install the unit by screwing two screws. It's recommended to use M4 or M5 screws.

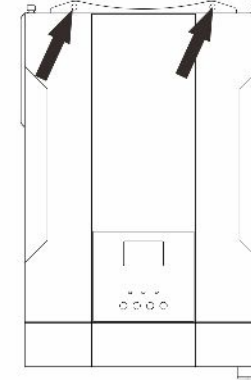

Battery Connection

CAUTION: For safety operation and regulation compliance, it's requested to install a separate DC over-current protector or disconnect device between battery and inverter. It may not be requested to have a disconnect device in some applications, however, it's still requested to have over-current protection installed. Please refer to typical amperage in below table as required fuse or breaker size.

WARNING! All wiring must be performed by a qualified personnel.

WARNING! It's very important for system safety and efficient operation to use appropriate cable for battery connection. To reduce risk of injury, please use the proper recommended cable as below.

Recommended battery cable size:

Model	Wire Size	Cable(mm ²)	Torque value(max)
3.5KW	1 x 4AWG	25	2 Nm
5.5KW	1 x 4AWG	25	

Please follow below steps to implement battery connection:

- 1.Remove insulation sleeve 18 mm for positive and negative conductors.
- 2.Suggest to put bootlace ferrules on the end of positive and negative wires with a proper crimping tool.
- 3.Fix strain relief plate to the inverter by supplied screws as shown in below chart.

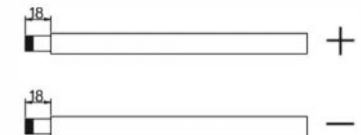

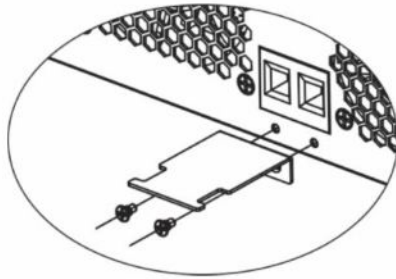

4.3.5KWmodel supports 24VDC system and 5.5KWmodel supports 48VDC system. Connect all battery packs as below chart. It's suggested to connect at least 100Ah capacity battery for 1-3.5 KW model and at least 200Ah capacity battery for 5.5KWmodel.

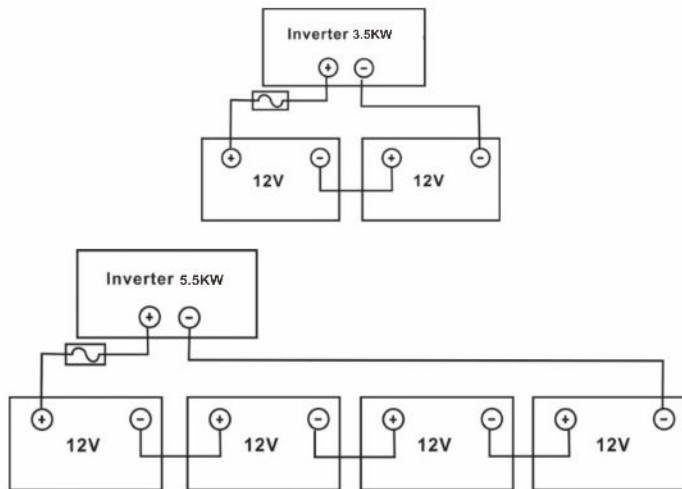

5. Insert the battery wires flatly into battery connectors of inverter and make sure the bolts are tightened with torque of 2 Nm in clockwise direction. Make sure polarity at both the battery and the inverter/charge is correctly connected and conductors are tightly screwed into the battery terminals.

Recommended tool: #2 Pozzi Screwdriver

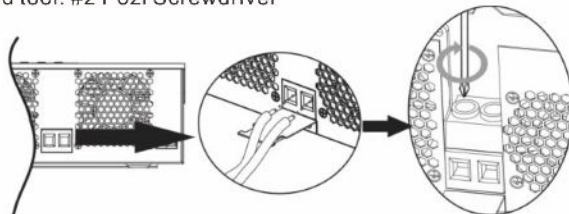

6. To firmly secure wire connection, you may fix the wires to strain relief with cable tie.

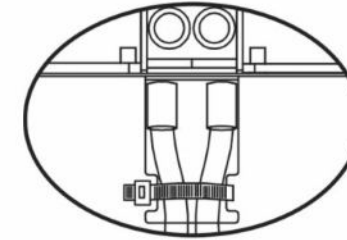

WARNING: Shock Hazard

Installation must be performed with care due to high battery voltage in series.



CAUTION!! Before making the final DC connection or closing DC breaker/disconnector, be sure positive (+) must be connected to positive (+) and negative (-) must be connected to negative(-).

AC Input/Output Connection

CAUTION!! Before connecting to AC input power source, please install a separate AC breaker between inverter and AC input power source. This will ensure the inverter can be securely disconnected during maintenance and fully protected from over current of AC input. The recommended spec of AC breaker is 32A for 3.5kW and 50A for 5.5kW. **CAUTION!!** There are two terminal blocks with "IN" and "OUT" markings. Please do NOT mis-connect input and output connectors.

WARNING! All wiring must be performed by a qualified personnel.

WARNING! It's very important for system safety and efficient operation to use appropriate cable for AC input connection. To reduce risk of injury, please use the proper recommended cable size as below.

Suggested cable requirement for AC wires

Model	Wire Size	Cable(mm ²)	Torque value(max)
3.5KW	12AWG	4	1.2 Nm
5.5KW	10AWG	6	1.2 Nm

Please follow below steps to implement AC input/output connection:

1. Before making AC input/output connection, be sure to open DC protector or disconnector first.
2. Remove insulation sleeve 10mm for six conductors. And shorten phase L and neutral conductor N 3 mm.
3. For 3.5KW-5.5KW models, insert AC input wires according to polarities indicated on terminal block and tighten the terminal screws. Be sure to connect PE protective conductor (⊕) first.

- ⊕ → Ground (yellow-green)
- L → LINE (brown or black)
- N → Neutral (blue)

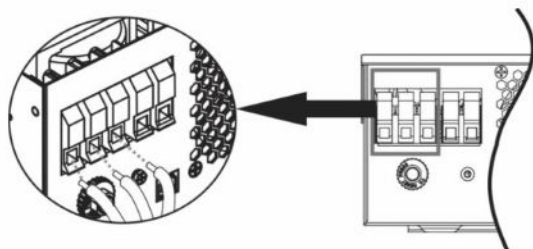

WARNING:

Be sure that AC power source is disconnected before attempting to hardwire it to the unit.

4. Then, insert AC output wires according to polarities indicated on terminal block and tighten terminal screws.

Be sure to connect PE protective conductor(⊕) first.

⊕ → Ground (yellow-green)

L → LINE (brown or black)

N → Neutral (blue)

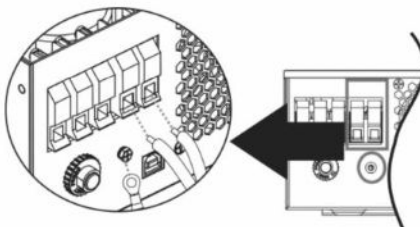

5. Make sure the wires are securely connected.

CAUTION: Appliances such as air conditioner are required at least 2~3 minutes to restart because it's required to have enough time to balance refrigerant gas inside of circuits. If a power shortage occurs and recovers in a short time, it will cause damage to your connected appliances. To prevent this kind of damage, please check manufacturer of air conditioner if it's equipped with time-delay function before installation. Otherwise, this inverter/charger will trig overload fault and cut off output to protect your appliance but sometimes it still causes internal damage to the air conditioner.

PV Connection

CAUTION: Before connecting to PV modules, please install separately a DC circuit breaker between inverter and PV modules.

WARNING! It's very important for system safety and efficient operation to use appropriate cable for PV module connection. To reduce risk of injury, please use the proper recommend cable size as below.

Model	Wire Size	Cable(mm ²)	Torque value(max)
3.5KW/5.5KW	1 x 12AWG	4	1.2 Nm

PV Module Selection:

When selecting proper PV modules, please be sure to consider below parameters:

1. Open circuit Voltage (Voc) of PV modules not exceeds max. PV array open circuit voltage of inverter.
2. Open circuit Voltage (Voc) of PV modules should be higher than min. battery voltage.

INVERTER MODEL	3.5KW	5.5KW
Max. PV Array Open Circuit Voltage	500Vdc	
PV Array MPPT Voltage Range	120Vdc~450Vdc	

Take 250Wp PV module as an example. After considering above two parameters, the recommended module configurations for 3.5KW, 3.5KWPlus and 5.5KW are listed as below table.

Solar Panel Spec (reference)	SOLAR INPUT	Qty of panels	Total input power
	(Min in serial:6 pcs,max.in serial:13 pcs)		
-250Wp	6 pcs in serial	6 pcs	1500W
-Vmp:30.1Vdc	8 pcs in serial	8 pcs	2000W
-Imp:8.3A	12 pcs in serial	12 pcs	3000W
-Voc:37.7Vdc	13 pcs in serial	13 pcs	3250W
-Isc:8.4A	8 pieces in serial and 2 sets in parallel	16 pcs	4000W
-Cells:60	10 pieces in serial and 2 sets in parallel	20 pcs	5000W
	12 pieces in serial and 2 sets in parallel	20 pcs	6000W

PV Module Wire Connection

Please follow below steps to implement PV module connection:

1. Remove insulation sleeve 10 mm for positive and negative conductors.
2. Suggest to put bootlace ferrules on the end of positive and negative wires with a proper crimping tool.

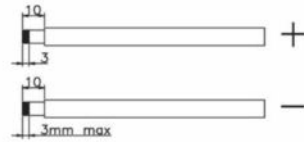

3. Fix strain relief plate to the inverter with supplied screws as shown in below chart.

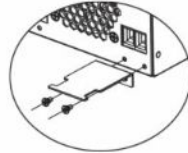

4. Check correct polarity of wire connection from PV modules and PV input connectors. Then, connect positive pole (+) of connection wire to positive pole (+) of PV input connector. Connect negative pole (-) of connection wire to negative pole (-) of PV input connector. Screw two wires tightly in clockwise direction. Recommended tool: 4mm blade screwdriver

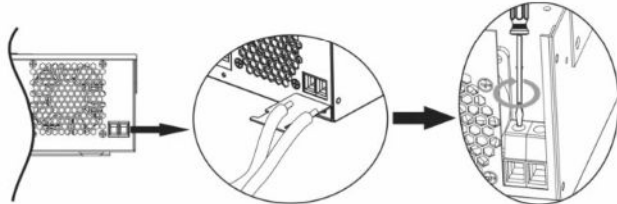

5. To ensure wires are securely connected, you fix wires to the strain relief with cable tie.

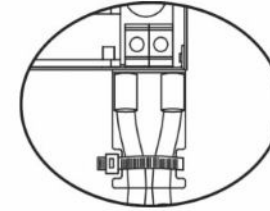

Final Assembly

After connecting all wirings, please put bottom cover back by screwing two screws as shown below.

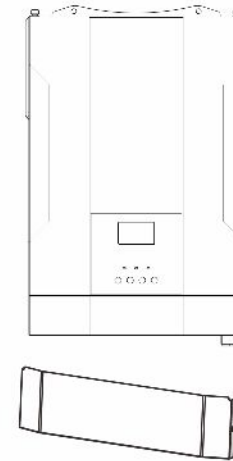

Communication Connection

Please use supplied communication cable to connect to inverter and PC. Insert bundled CD into a computer and follow on-screen instruction to install the monitoring software. For the detailed software operation, please check user manual of software inside of CD.

OPERATION

Power ON/OFF

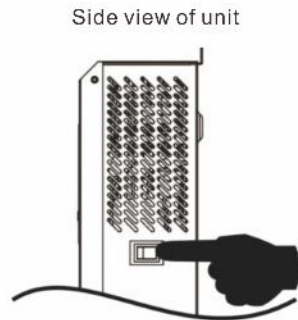

Once the unit has been properly installed and the batteries are connected well, simply press On/Off switch (located on the button of the case) to turn on the unit.

Operation and Display Panel

The operation and display panel, shown in below chart, is on the front panel of the inverter. It includes three indicators, four function keys and a LCD display, indicating the operating status and input/output power information.

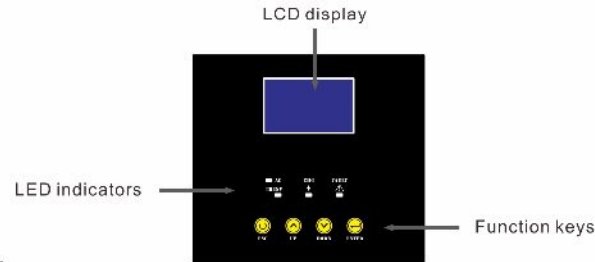

LED Indicator

LED Indicator		Messages	
AC / INV	Green	Solid On	Output is powered by utility in Line mode.
		Flashing	Output is powered by battery or PV in battery mode.
CHG	Green	Solid On	Battery is fully charged.
		Flashing	Battery is charging.
FAULT	Red	Solid On	Fault occurs in the inverter.
		Flashing	Warning condition occurs in the inverter.

Function Keys

Function Key	Description
ESC	To exit setting mode
UP	To go to previous selection
DOWN	To go to next selection
ENTER	To confirm the selection in setting mode or enter setting mode

LCD Display Icons

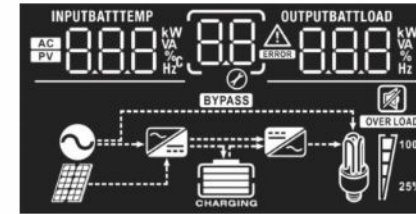

Icon	Function description
Input Source Information	
	Indicates the AC input.
	Indicates the PV input
	Indicate input voltage, input frequency, PV voltage, charger current (if PV in charging for 3.5K models), charger power (only for MPPT models), battery voltage.
Configuration Program and Fault Information	
	Indicates the setting programs.
	Indicates the warning and fault codes. Warning: flashing with warning code. Fault: lighting with fault code
Output Information	
	Indicate output voltage, output frequency, load percent, load in VA, load in Watt and discharging current.
Battery Information	
	Indicates battery level by 0-24%, 25-49%, 50-74% and 75-100% in battery mode and charging status in line mode.

In AC mode, it will present battery charging status.

Status	Battery voltage	LCD Display
Constant Current mode / Constant Voltage mode	< 2V/cell	4 bars will flash in turns.
	2 ~ 2.083V/cell	Bottom bar will be on and the other three bars will flash in turns.
	2.083 ~ 2.167V/cell	Bottom two bars will be on and the other two bars will flash in turns.
	> 2.167 V/cell	Bottom three bars will be on and the top bar will flash.
Floating mode. Batteries are fully charged.		4 bars will be on.

In battery mode, it will present battery capacity.

Load Percentage	Battery Voltage	LCD Display
Load >50%	< 1.85V/cell	
	1.85V/cell ~ 1.933V/cell	
	1.933V/cell ~ 2.017V/cell	
	> 2.017V/cell	
Load < 50%	< 1.892V/cell	
	1.892V/cell ~ 1.975V/cell	
	1.975V/cell ~ 2.058V/cell	
	> 2.058V/cell	

Load Information

OVER LOAD

Indicates overload.

Indicates the load level by 0-24%, 25-49%, 50-74% and 75-100%.



0%~24%	25%~49%	50%~74%	75%~100%

Mode Operation Information



Indicates unit connects to the mains.



Indicates unit connects to the PV panel.

BYPASS

Indicates load is supplied by utility power.



Indicates the utility charger circuit is working.



Indicates the DC/AC inverter circuit is working.

Mute Operation



Indicates unit alarm is disabled.

LCD Setting

After pressing and holding ENTER button for 3 seconds, the unit will enter setting mode. Press "UP" or "DOWN" button to select setting programs. And then, press "ENTER" button to confirm the selection or ESC button to exit.

Setting Programs:

Program	Description	Selectable option	
00	Exit setting mode	Escape 	
01	Output source priority: To configure load power source priority	Solar first 	Solar energy provides power to the loads as first priority. If solar energy is not sufficient to power all connected loads, battery energy will supply power to the loads at the same time. Utility provides power to the loads only when any one condition happens: -Solar energy is not available -Battery voltage drops to low-level warning voltage or the setting point in program 12.
		Utility first (default) 	Utility will provide power to the loads as first priority. Solar and battery energy will provide power to the loads only when utility power is not available.
		SBU priority 	Solar energy provides power to the loads as first priority. If solar energy is not sufficient to power all connected loads, battery energy will supply power to the loads at the same time. Utility provides power to the loads only when battery voltage drops to either low-level warning voltage or the setting point in program 12.

02	Maximum charging current: To configure total charging current for solar and utility chargers. (Max. charging current= utility charging current + solar charging current)	10A 02 10 ^A	20A 02 20 ^A
		30A 02 30 ^A	40A 02 40 ^A
		50A 02 50 ^A	60A(default) 02 60 ^A
		70A 02 70 ^A	80A 02 80 ^A
		90A 02 90 ^A	100A 02 100 ^A
03	AC input voltage range	Appliances (default) 03 APL	If selected, acceptable AC input voltage range will be within 90-280VAC.
		UPS 03 UPS	If selected, acceptable AC input voltage range will be within 170-280VAC.
05	Battery type	AGM (default) 05 AGM	Flooded 05 FLD
		User-Defined 05 USE	If "User-Defined" is selected, battery charge voltage and low DC cut-off voltage can be set up in program 26, 27 and 29.
06	Auto restart when overload occurs	Restart disable (default) 06 LFD	Restart enable 06 LFE
07	Auto restart when over temperature occurs	Restart disable (default) 07 LFD	Restart enable 07 LFE

09	Output frequency	50Hz (default) 09 50 ^{Hz}	60Hz 09 60 ^{Hz}
10	Out voltage	220V 10 220 ^v	230V (default) 10 230 ^v
		240V 10 240 ^v	
11	Maximum utility charging current Note: If setting value in program 02 is smaller than that in program in 11, the inverter will apply charging current from program 02 for utility charger.	2A 11 2A	10A 11 10A
		20A 11 20A	30A(default) 11 30A
		40A 11 40A	50A 11 50A
		60A 11 60A	70A 11 70A
		80A 11 80A	
12	Setting voltage point back to utility source when selecting "SBU priority" or "Solar first" in program 01.	Available options in 3.5KWmodel:	
		22.0V 12 220 ^v	22.5V 12 225 ^v
		23.0V(default) 12 230 ^v	23.5V 12 235 ^v
		24.0V 12 240 ^v	24.5V 12 245 ^v
		25.0V 12 250 ^v	25.5V 12 255 ^v

12	Setting voltage point back to utility source when selecting "SBU priority" or "Solar first" in program 01.	Available options in 5.5KW model:	
		44V 12 ^{BATT} 44v	45V 12 ^{BATT} 45v
		46V (default) 12 ^{BATT} 46v	47V 12 ^{BATT} 47v
		48V 12 ^{BATT} 48v	49V 12 ^{BATT} 49v
		50V 12 ^{BATT} 50v	51V 12 ^{BATT} 51v
13	Setting voltage point back to battery mode when selecting "SBU priority" or "Solar first" in program 01.	Available options in 3.5KW model:	
		Battery fully charged 13 ^{BATT} FUL	24V 13 ^{BATT} 24.0v
		24.5V 13 ^{BATT} 24.5v	25V 13 ^{BATT} 25.0v
		25.5V 13 ^{BATT} 25.5v	26V 13 ^{BATT} 26.0v
		26.5V 13 ^{BATT} 26.5v	27V (default) 13 ^{BATT} 27.0v
		27.5V 13 ^{BATT} 27.5v	28V 13 ^{BATT} 28.0v
		28.5V 13 ^{BATT} 28.5v	29V 13 ^{BATT} 29.0v

13	Setting voltage point back to battery mode when selecting "SBU priority" or "Solar first" in program 01.	Available options in 5.5KW model:	
		Battery fully charged 13 ^{BATT} FUL	48V 13 ^{BATT} 48.0v
		49V 13 ^{BATT} 49.0v	50V 13 ^{BATT} 50.0v
		51V 13 ^{BATT} 51.0v	52V 13 ^{BATT} 52.0v
		53V 13 ^{BATT} 53.0v	54V (default) 13 ^{BATT} 54.0v
		55V 13 ^{BATT} 55.0v	56V 13 ^{BATT} 56.0v
		57V 13 ^{BATT} 57.0v	58V 13 ^{BATT} 58.0v
16	Charger source priority: To configure charger source priority	If this inverter/charger is working in Line, Standby or Fault mode, charger source can be programmed as below:	
		Solar first 16 ^{BATT} C50	Solar energy will charge battery as first priority. Utility will charge battery only when solar energy is not available.
		Utility first 16 ^{BATT} CUE	Utility will charge battery as first priority. Solar energy will charge battery only when utility power is not available.
		Solar and Utility (default) 16 ^{BATT} 50U	Solar energy and utility will charge battery at the same time.
		Only Solar 16 ^{BATT} 050	Solar energy will be the only charger source no matter utility is available or not.
		If this inverter/charger is working in Battery mode or Power saving mode, only solar energy can charge battery. Solar energy will charge battery if it's available and sufficient.	

18	Alarm control	Alarm on (default) 18 b0N	Alarm off 18 b0F
19	Auto return to default display screen	Return to default display screen (default) 19 ESP	If selected, no matter how users switch display screen, it will automatically return to default display screen (Input voltage /output voltage) after no button is pressed for 1 minute.
		Stay at latest screen 19 FEP	If selected, the display screen will stay at latest screen user finally switches.
20	Backlight control	Backlight on (default) 20 LON	Backlight off 20 LOF
22	Beeps while primary source is interrupted	Alarm on (default) 22 AON	Alarm off 22 AOF
23	Overload bypass: When enabled, the unit will transfer to line mode if overload occurs in battery mode.	Bypass disable (default) 23 byd	Bypass enable 23 byE
25	Record Fault code	Record enable (default) 25 FEN	Record disable 25 FdS
26	Bulk charging voltage (C.V voltage)	3.5KW default setting: 28.2V CU 26 ^{BATT} 28.2V	
		5.5KW default setting: 56.4V CU 26 ^{BATT} 56.4V	
		If self-defined is selected in program 5, this program can be set up. Setting range is from 12.5V to 15.0V for 1KW model, 25.0V to 30.0V for 2KW model, 25.0V to 31.5V for 3.5KW model and 48.0V to 61.0V for Increment of each click is 0.1V.	

27	Floating charging voltage	3.5KVA default setting: 27.0V FLU 27 ^{BATT} 27.0V	
		5KVA default setting: 54.0V FLU 27 ^{BATT} 54.0V	
		If self-defined is selected in program 5, this program can be set up. Setting range is from 12.5V to 15.0V for 1KW model, 25.0V to 30.0V for 2KW model, 25.0V to 31.5V for 3KW/3.5KW model and 48.0V to 61.0V for 5.5KW model. Increment of each click is 0.1V.	
29	Low DC cut-off voltage	3.5KW default setting: 21.0V COU 29 ^{BATT} 21.0V	
		5.5KW default setting: 42.0V COU 29 ^{BATT} 42.0V	
		If self-defined is selected in program 5, this program can be set up. Setting range is from 10.5V to 12.0V for 1KW model, 21.0V to 24.0V for 2KW/3KW/3.5KW model and 42.0V to 48.0V for 5.5KW model. Increment of each click is 0.1V. Low DC cut-off voltage will be fixed to setting value no matter what percentage of load is connected.	
30	Battery equalization	Battery equalization 30 EEN	Battery equalization disable (default) 30 EdS
		If "Flooded" or "User-Defined" is selected in program 05, this program can be set up.	
31	Battery equalization voltage	3.5KW default setting: 29.2V EU 31 ^{BATT} 29.2V	
		5.5KW default setting: 58.4V EU 31 ^{BATT} 58.4V	
		Setting range is from 12.5V to 15.0V for 1KW model, 25.0V to 30.0V for 2KW model, 25.0V to 31.5V for 3KW/3.5KW model and 48.0V to 61.0V for 5.5KW model. Increment of each click is 0.1V.	

33	Battery equalized time	60min (default) 33 60	Setting range is from 5min to 900min. Increment of each click is 5min.
34	Battery equalized timeout	120min (default) 34 120	Setting range is from 5min to 900 min. Increment of each click is 5 min.
35	Equalization interval	120min (default) 35 30d	Setting range is from 0 to 90 days. Increment of each click is 1 day
36	Equalization activated immediately	Enable 36 AEN	Disable (default) 36 AdS
		If equalization function is enabled in program 30, this program can be set up. If "Enable" is selected in this program, it's to activate battery equalization immediately and LCD main page will shows "E9". If "Disable" is selected, it will cancel equalization function until next activated equalization time arrives based on program 35 setting. At this time, "E9" will not be shown in LCD main page.	

Display Setting

The LCD display information will be switched in turns by pressing "UP" or "DOWN" key. The selectable information is switched as below order: input voltage, input frequency, PV voltage, charging current, charging power (only for MPPT models), battery voltage, output voltage, output frequency, load percentage, load in Watt, load in W, load in Watt, DC discharging current, main CPU Version and second CPU Version.

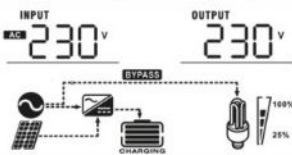

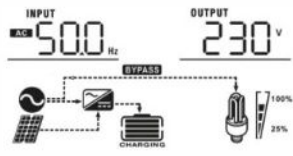
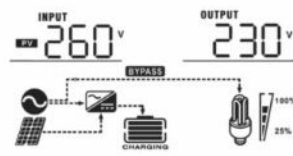
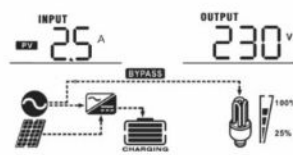
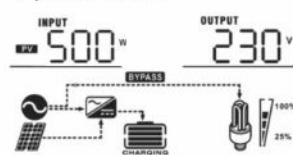
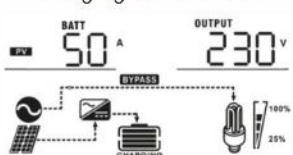
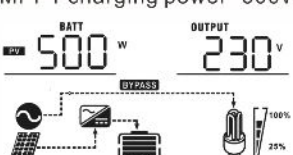

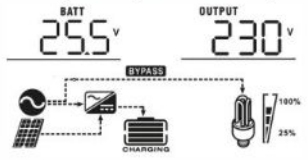
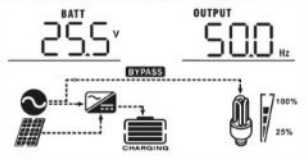
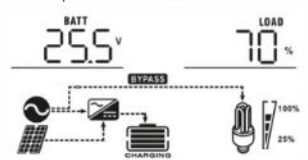
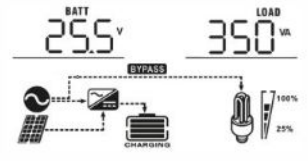
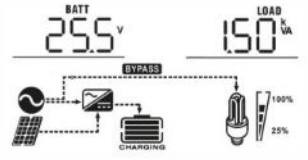

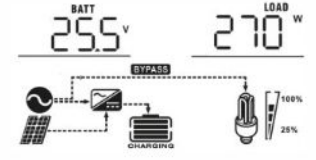
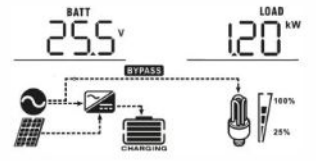
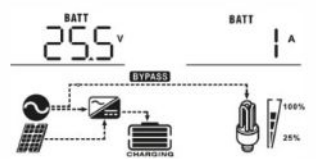
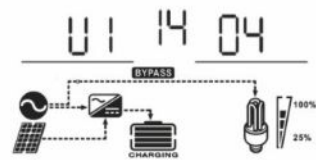

Selectable information	LCD display
Input voltage/Output voltage (Default Display Screen)	Input Voltage=230V, output voltage=230V 



Selectable information	LCD display
Input frequency	Input frequency=50Hz 
PV voltage	PV voltage=260V 
PV current	PV current=2.5A 
PV power	PV power=500W 
Charging current	PV charging current =50A 
Charging power	MPPT charging power=500W 

Selectable information	LCD display
Battery voltage and output voltage	<p>Battery voltage=25.5V, output voltage=230V</p> 
Output frequency	<p>Output frequency=50Hz</p> 
Load percentage	<p>Load percent=70%</p> 
Load in VA	<p>When connected load is lower than 1kVA, load in VA will present xxxVA like below chart.</p>  <p>When load is larger than 1kVA ($\geq 1\text{KVA}$), load in VA will present x.xkVA like below chart.</p> 

Selectable information	LCD display
Load in Watt	<p>When load is lower than 1kW, load in W will present xxxW like below chart.</p>  <p>When load is larger than 1kW ($\geq 1\text{KW}$), load in W will present x.xkW like below chart.</p> 
Battery voltage/DC discharging current	<p>Battery voltage=25.5V, discharging current=1A</p> 
Main CPU version checking	<p>Main CPU version 00017.04</p> 

Operating Mode Description

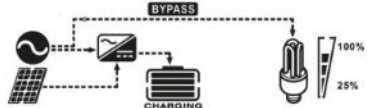
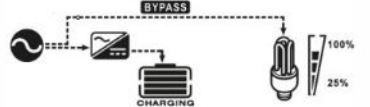
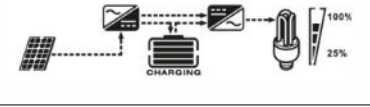
Operation mode	Description	LCD display
Standby mode / Power saving mode Note: *Standby mode: The inverter is not turned on yet but at this time, the inverter can charge battery without AC output. *Power saving mode: If enabled, the output of inverter will be off when connected load is pretty low or not detected.	No output is supplied by the unit but it still can charge batteries.	Charging by utility and PV energy. 
		Charging by utility. 
		Charging by PV energy. 
		No charging. 
Fault mode Note: *Fault mode: Errors are caused by inside circuit error or external reasons such as over temperature, output short circuited and so on.	PV energy and utility can charge batteries.	Charging by utility and PV energy. 
		Charging by utility. 
		Charging by PV energy. 
		No charging. 

Operation mode	Description	LCD display
Line Mode	The unit will provide output power from the mains. It will also charge the battery at line mode.	Charging by utility and PV energy. 
		Charging by utility. 
Battery Mode	The unit will provide output power from battery and PV power.	Power from battery and PV energy. 
		Power from battery only. 

Battery Equalization Description

Equalization function is added into charge controller. It reverses the buildup of negative chemical effects like stratification, a condition where acid concentration is greater at the bottom of the battery than at the top. Equalization also helps to remove sulfate crystals that might have built up on the plates. If left unchecked, this condition, called sulfation, will reduce the overall capacity of the battery. Therefore, it's recommended to equalize battery periodically.

How to Apply Equalization Function

You must enable battery equalization function in monitoring LCD setting program 30 first. Then, you may apply this function in device by either one of following methods:

1. Setting equalization interval in program 35.
2. Active equalization immediately in program 36.

When to Equalize

In float stage, when the setting equalization interval (battery equalization cycle) is arrived, or equalization is active immediately, the controller will start to enter Equalize stage.

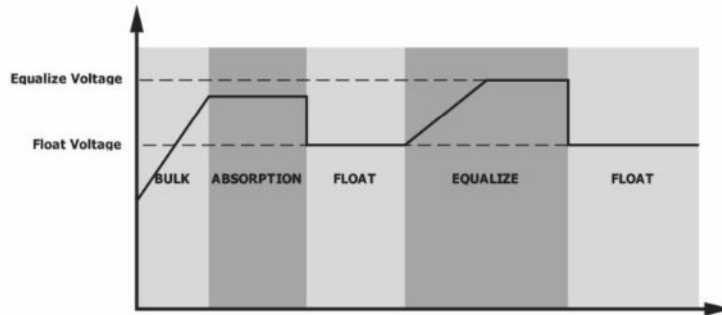

Equalize charging time and timeout

In Equalize stage, the controller will supply power to charge battery as much as possible until battery voltage raises to battery equalization voltage. Then, constant-voltage regulation is applied to maintain battery voltage at the battery equalization voltage. The battery will remain in the Equalize stage until setting battery equalized time is arrived.

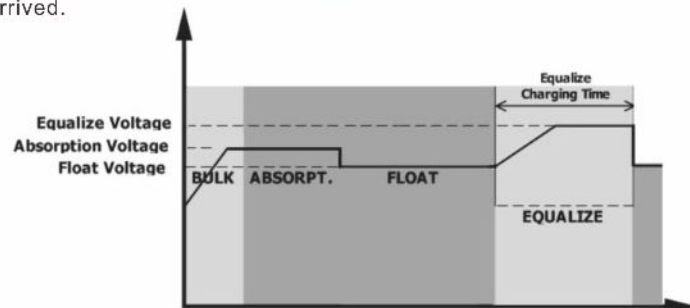

However, in Equalize stage, when battery equalized time is expired and battery voltage doesn't rise to battery equalization voltage point, the charge controller will extend the battery equalized time until battery voltage achieves battery equalization voltage. If battery voltage is still lower than battery equalization voltage when battery equalized timeout setting is over, the charge controller will stop equalization and return to float stage.

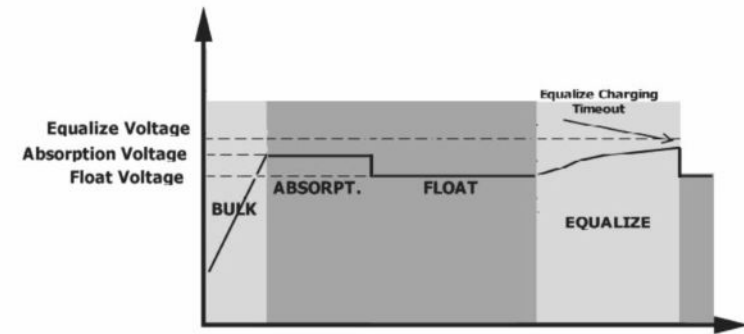

CLEARANCE AND MAINTENANCE FOR ANTI-DUST KIT

Overview

Every inverter is already installed with anti-dusk kit from factory. Inverter will automatically detect this kit and activate internal thermal sensor to adjust internal temperature. This kit also keeps dusk from your inverter and increases product reliability in harsh environment.

Clearance and Maintenance

Step 1: Please loosen the screw in counterclockwise direction on the top of the inverter.

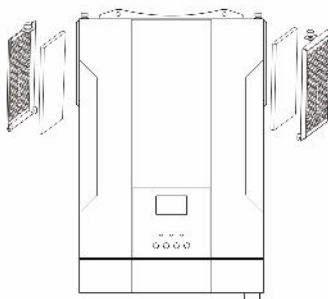

Step 2: Then, dustproof case can be removed and take out air filter foam as shown in below chart.

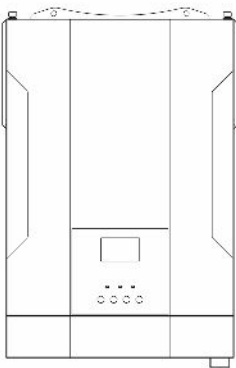

Step 3: Clean air filter foam and dustproof case. After clearance, re-assemble the dust-kit back to the inverter.

NOTICE: The anti-dust kit should be cleaned from dust every one month.

Fault Reference Code

Fault Code	Fault Event	Icon on
1	Fan is locked when inverter is off.	01
2	Over temperature	02
3	Battery voltage is too high	03
4	Battery voltage is too low	04
5	Output short circuited or over temperature is detected by internal converter components.	05
6	Output voltage is abnormal. (For 3KW model) Output voltage is too high. (For 3KW Plus/5KW model)	06
7	Overload time out	07
8	Bus voltage is too high	08
9	Bus soft start failed	09
51	Over current or surge	51
52	Bus voltage is too low	52
53	Inverter soft start failed	53
55	Over DC voltage in AC output	55
56	Battery connection is open	56
57	Current sensor failed	57
58	Output voltage is too low	58
59	PV voltage is over limitation	59

Warning Indicator

Warning Code	Warning Event	Audible Alarm	Icon flashing
01	Fan is locked when inverter is on.	Beep three times every second	01 ^Δ
02	Over temperature	None	02 ^Δ
03	Battery is over-charged	Beep once every second	03 ^Δ
04	Low battery	Beep once every second	04 ^Δ
07	Overload	Beep once every 0.5 second	07 ^Δ OVERLOAD
10	Output power derating	Beep twice every 3 seconds	10 ^Δ
15	PV energy is low	Beep twice every 3 seconds	15 ^Δ
16	High AC input(>280VAC) during BUS soft start	None	16 ^Δ
E9	Battery equalization	None	E9 ^Δ
bp	Battery is not connected	None	bp ^Δ

SPECIFICATIONS

Table 1 Line Mode Specifications

INVERTER MODEL	3.5KW	5.5KW
Input Voltage Waveform	Sinusoidal (utility or generator)	
Nominal Input Voltage	230Vac	
Low Loss Voltage	170Vac±7V (UPS); 90Vac±7V (Appliances)	
Low Loss Return Voltage	180Vac±7V (UPS); 100Vac±7V (Appliances)	
High Loss Voltage	280Vac±7V	
High Loss Return Voltage	270Vac±7V	
Max AC Input Voltage	300Vac	
Nominal Input Frequency	50Hz / 60Hz (Auto detection)	
Low Loss Frequency	40±1Hz	
Low Loss Return Frequency	42±1Hz	
High Loss Frequency	65±1Hz	
High Loss Return Frequency	63±1Hz	
Output Short Circuit Protection	Circuit Breaker	
Efficiency (Line Mode)	>95% (Rated R load, battery full charged)	
Transfer Time	10ms typical (UPS); 20ms typical (Appliances)	
Output power derating: When AC input voltage drops to 170V, the output power will be derated.		

Table 2 Inverter Mode Specifications

INVERTER MODEL	3.5KW	5.5KW
Rated Output Power	3.5KW	5.5KW
Output Voltage Waveform	Pure Sine Wave	
Output Voltage Regulation	230Vac±5%	
Output Frequency	50Hz	
Peak Efficiency	93%	
Overload Protection	5s@≥150% load; 10s@110%~150% load	
Surge Capacity	2* rated power for 5 seconds	
Nominal DC Input Voltage	24Vdc	48Vdc
Cold Start Voltage	23.0Vdc	46.0Vdc
Low DC Warning Voltage		
@ load < 50%	23.0Vdc	46.0Vdc
@ load ≥ 50%	22.0Vdc	44.0Vdc
Low DC Warning Return Voltage		
@ load < 50%	23.5Vdc	47.0Vdc
@ load ≥ 50%	23.0Vdc	46.0Vdc
Low DC Cut-off Voltage		
@ load < 50%	21.5Vdc	43.0Vdc
@ load ≥ 50%	21.0Vdc	42.0Vdc
High DC Recovery Voltage	32Vdc	62Vdc
High DC Cut-off Voltage	33Vdc	63Vdc
No Load Power Consumption	<35W	<35W

Table 3 Charge Mode Specifications

Utility Charging Mode			
INVERTER MODEL		3.5KW	5.5KW
Charging Algorithm		3-Step	
AC Charging Current (Max)		80Amp(@VI/P=230Vac)	80Amp (@VI/P=230Vac)
Bulk Charging	Flooded Battery	29.2	58.4
Voltage	AGM / Gel Battery	28.2	56.4
Floating Charging Voltage		27Vdc	54Vdc
Charging Curve			
MPPT Solar Charging Mode			
INVERTER MODEL		3.5KW	5.5KW
MAX.PV Array Power		5000W	6000W
Nominal PV Voltage		240Vdc	
PV Array MPPT Voltage Range		120V-450Vdc	
MAX.PV Array Open Circuit Voltage		500Vdc	
Max Charging Current (AC charger plus solar charger)		100Amp	

Table 4 General Specifications

INVERTER MODEL	3.5KW	5.5KW
Safety Certification	CE	
Operating Temperature Range	-10°C to 50°C	
Storage temperature	-15°C~ 60°C	
Humidity	5% to 95% Relative Humidity (Non-condensing)	
Dimension (D*W*H), mm	117*313*481	
Net Weight, kg	10	10.5

TROUBLE SHOOTING

Problem	LCD/LED/Buzzer	Explanation / Possible cause	Problem
Unit shuts down automatically during startup process	LCD/LEDs and buzzer will be active for 3 seconds and then complete off	The battery voltage is too low (<1.91V/Cell)	1. Re-charge battery. 2. Replace battery.
No response after power on	No indication	1.The battery voltage is far too low. (<1.4V/Cell) 2.Internal fuse tripped	1.Contact repair center for replacing the fuse 2.Re-charge battery 3.Replace battery
Mains exist but the unit works in battery mode.	Input voltage is displayed as 0 on the LCD and green LED is flashing	Input protector is tripped	Check if AC breaker is tripped and AC wiring is connected well
	Green LED is flashing	Insufficient quality of AC power. (Shore or Generator)	1.Check if AC wires are too thin and/or too long. 2.Check if generator (if applied) is working well or if input voltage range setting is correct. (UPS →Appliance)
	Green LED is flashing	Set "Solar First" as the priority of output source	Change output source priority to Utility first
When the unit is turned on, internal relay is switched on and off repeatedly	LCD display and LEDs are flashing	Battery is disconnected	Check if battery wires are connected well
Buzzer beeps continuously and red LED is on	Fault code 07	Overload error. The inverter is overload 110% and time is up	Reduce the connected load by switching off some equipment
	Fault code 05	Output short circuited	Check if wiring is connected well and remove abnormal load
		Temperature of internal converter component is over 120°C. (Only available for 1-3KW models)	Check whether the air flow of the unit is blocked or whether the ambient temperature is too high
Fault code 02	Internal temperature of inverter component is over 100°C		

Problem	LCD/LED/Buzzer	Explanation / Possible cause	Problem
Buzzer beeps continuously and red LED is on	Fault code 03	Battery is over-charged	Return to repair center
		The battery voltage is too high	Check if spec and quantity of batteries are meet requirements
	Fault code 01	Fan fault	Replace the fan
	Fault code 06/58	Output abnormal (Inverter voltage below than 190Vac or is higher than 260Vac)	1.Reduce the connected load. 2.Return to repair center
	Fault code 08/09/53/57	Internal components failed	Return to repair center
	Fault code 51	Over current or surge	Restart the unit, if the error happens again, please return to repair center
	Fault code 52	Bus voltage is too low	
	Fault code 55	Output voltage is unbalanced	
	Fault code 59	PV input voltage is beyond the specification	Reduce the number of pv modules in series

Appendix: Approximate Back-up Time Table

Model	Load (W)	Backup Time @ 24Vdc 100Ah (min)	Backup Time @ 24Vdc 200Ah (min)
3.5KW	300	449	1100
	600	222	525
	900	124	303
	1200	95	227
	1500	68	164
	1800	56	126
	2100	48	108
	2400	35	94
	2700	31	74
3000	28	67	

Model	Load (W)	Backup Time @ 48Vdc 100Ah (min)	Backup Time @ 48Vdc 200Ah (min)
5.5KW	500	613	1288
	1000	268	613
	1500	158	402
	2000	111	271
	2500	90	215
	3000	76	182
	3500	65	141
	4000	50	112
	4500	44	100
5000	40	90	

Note: Backup time depends on the quality of the battery, age of battery and type of battery.
Specifications of batteries may vary depending on different manufacturers.